

# MANUAL FOR SOVIET *MOSIN-NAGANT*

MODELS OF  
1891 -- 1910 -- 1891/30 -- 1938 -- 1944

RIFLES, CARBINES &  
SNIPER RIFLES

ORDI 7-101

CHAPTER 2



---

ORDNANCE CORPS

MAY 1954

## CHAPTER 2. BOLT ACTION RIFLES AND CARBINES

|   | Paragraph | Page |
|---|-----------|------|
| <b>SECTION I. GENERAL</b>   |           |      |
| Origin and basic qualities -----                                    | 5         | 2    |
| Bolt action rifles -----  | 6         | 2    |
| Bolt action carbines -----  | 7         | 3    |
| Characteristics of 7.62-mm bolt action rifles<br>and carbines ----- | 8         | 4    |
| <b>II. DIFFERENCES BETWEEN MODELS</b>                               |           |      |
| Rifle M1891 -----   | 9         | 6    |
| Dragoon rifle M1891 -----   | 10        | 7    |
| Carbine M1910 -----   | 11        | 8    |
| Rifle M1891/30 -----  | 12        | 9    |
| Sniper rifle M1891/30 -----   | 13        | 12   |
| Carbine M1938 -----   | 14        | 16   |
| Carbine M1944 -----   | 15        | 16   |
| <b>III. INTERCHANGEABILITY</b>                                      |           |      |
| Components interchangeable between all models ---                   | 16        | 17   |
| Components interchangeable between specified<br>models -----        | 17        | 17   |
| <b>IV. AMMUNITION</b>   |           |      |
| Description -----   | 18        | 18   |
| Packaging -----   | 19        | 19   |
| <b>V. SIGHTING EQUIPMENT</b>  |           |      |
| Rifle M1891 -----   | 20        | 20   |
| Dragoon rifle M1891 -----   | 21        | 20   |
| Carbine M1910 -----   | 22        | 20   |
| Rifle M1891/30 -----  | 23        | 20   |
| Sniper rifle M1891/30 -----   | 24        | 21   |
| Carbine M1938 -----   | 25        | 21   |
| Carbine M1944 -----   | 26        | 22   |
| <b>VI. OPERATING INSTRUCTIONS</b>                                   |           |      |
| Rifle M1891 -----   | 27        | 22   |
| Dragoon rifle M1891 -----   | 28        | 23   |
| Carbine M1910 -----   | 29        | 23   |
| Rifle M1891/30 -----  | 30        | 24   |
| Sniper rifle M1891/30 -----   | 31        | 24   |
| Carbine M1938 -----   | 32        | 24   |
| Carbine M1944 -----   | 33        | 24   |
| <b>VII. MAINTENANCE</b>   |           |      |
| Accessories -----   | 34        | 24   |
| Care and cleaning -----   | 35        | 26   |
| Rifle M1891 -----   | 36        | 26   |
| Dragoon rifle M1891 -----   | 37        | 30   |
| Carbine M1910 -----   | 38        | 30   |
| Rifle M1891/30 -----  | 39        | 30   |
| Sniper rifle M1891/30 -----   | 40        | 30   |
| Carbine M1938 -----   | 41        | 30   |
| Carbine M1944 -----   | 42        | 30   |
| <b>VIII. MALFUNCTIONS AFFECTING OPERATIONS</b>                      |           |      |
| General -----   | 43        | 30   |
| Causes and correction of common malfunctions -----                  | 44        | 31   |

CHAPTER 2  
BOLT ACTION RIFLES AND CARBINES

SECTION I. GENERAL

5. ORIGIN AND BASIC QUALITIES

The Mosin-Nagant rifle was adopted in 1891 by Imperial Russia. The action of the rifle was developed by Colonel S. I. Mosin of the Imperial Russian Army, and the magazine was developed by Nagant, a Belgian. All Soviet bolt action military rifles and carbines are Mosin-Nagant weapons and all are basically similar to the original Mosin-Nagant rifle adopted by Russia in 1891. These weapons can be considered reasonably effective infantry weapons. Fairly good shooting can be done with them at combat ranges, although their sights do not lend themselves to the finer degrees of accuracy which can be obtained with similar United States weapons. They suffer from an overcomplicated bolt, but in other respects are relatively simple to service and maintain. The safety, in that it is extremely hard to engage and disengage, represents a shortcoming of the weapons.

6. BOLT ACTION RIFLES

a. The original rifle M1891 was considerably different than later versions of the same model. The original rifle M1891 had no handguard, was fitted with sling swivels instead of the sling slots used on later versions, and had a leaf rear sight which was designed for the old conical-nosed 7.62-mm ball cartridge. In 1908 the Spitzer pointed light ball round (which is still used) was introduced and the rear sight was changed. About this time handguards were added and the swivels were replaced by sling slots bored in the stock. The original M1891 is now a collector's item, and is unlikely to be encountered in the field. The later versions of the rifle M1891 (fig. 1) are no longer being manufactured, and are believed to be obsolete.

b. The Dragoon rifle M1891 (fig. 2) was originally developed as a weapon for heavy cavalry. Manufacture of this rifle was discontinued about 1930, when it was replaced by the rifle M1891/30. The Dragoon rifle M1891 is believed to be obsolete, but it may be found in limited quantity in satellite armies.



FIGURE 1. 7.62-MM RIFLE M1891.



FIGURE 2. 7.62-MM RIFLE M1891, DRAGOON.

c. The rifle M1891/30 (fig. 3) is about the same length as the M1891 Dragoon, but it represents many improvements over the Dragoon. The sights used on the M1891/30 are superior to those of the Dragoon, and, because the metric system of measurement was adopted in Russia during this period, the sights of the M1891/30 are calibrated in meters rather than in arshins. (One arshin equals 0.71 meters or 0.78 yards.) Manufacture of the M1891/30

FIGURE 3. 7.62-MM RIFLE M1891/30.

d. The sniper rifle M1891/30 (fig. 4), which is basically the M1891/30 adapted for use with a telescope, is a standard weapon in Soviet and satellite armies. The telescopes employed are somewhat similar to those used on United States hunting rifles.



FIGURE 4. 7.62-MM SNIPER RIFLE M1891/30.

#### 7. BOLT ACTION CARBINES

a. Although Imperial Russia adopted the Mosin-Nagant rifle in 1891, a true carbine did not appear until 1910. The carbine M1910 (fig. 5), with its leaf sight and sling slots, has characteristics of both the original and later versions of the rifle M1891. The carbine M1910 has a hexagonal receiver and does not take a bayonet. This model is comparatively rare and is believed to be obsolete.



FIGURE 5. 7.62-MM CARBINE M1910.

**SOVIET RIFLES AND CARBINES**  
**IDENTIFICATION AND OPERATION**

ORDI 7-101

May 1954

b. The carbine M1938 (fig. 6) replaced the M1910. It is similar in many respects to the rifle M1891/30. It has a tangent-type rear sight, hooded front sight, and rounded receiver. It does not take a bayonet. This model may be encountered in Soviet and satellite forces although it is not believed to be manufactured at present.

**ILLUSTRATION OMITTED**

FIGURE 6. 7.62-MM CARBINE M1938.

c. The carbine M1944 (fig. 7), introduced during the latter part of World War II, is now considered standard. The permanently fixed bayonet folds down along the right side of the carbine stock when not in use. Except for a slightly longer barrel and the addition of the bayonet, the carbine M1944 is identical to the M1938.

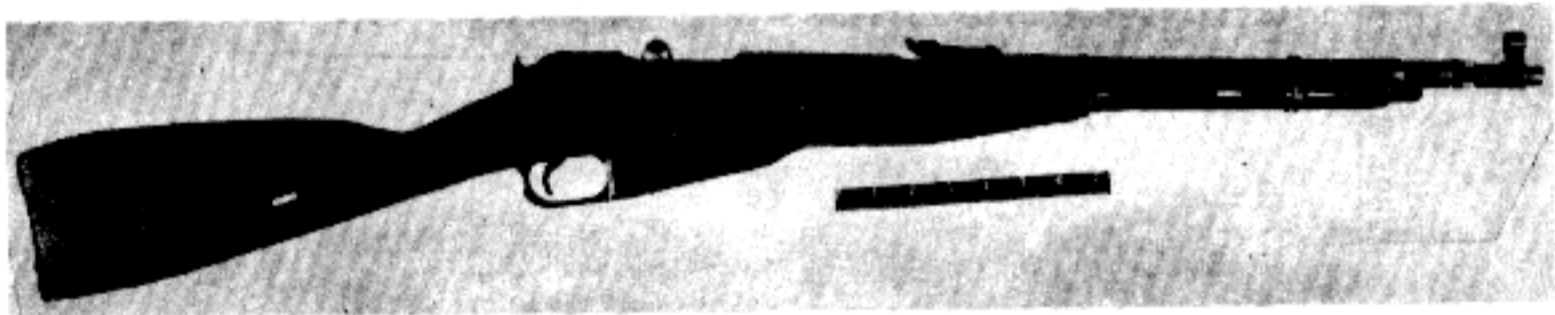

FIGURE 7. 7.62-MM CARBINE M1944.

**8. CHARACTERISTICS OF 7.62-MM BOLT ACTION RIFLES AND CARBINES**

Basic characteristics of 7.62-mm bolt action rifles and carbines are presented in table I.

SOVIET RIFLES AND CARBINES

IDENTIFICATION AND OPERATION

May 1954

ORDI 7-101

Table I. Characteristics of 7.62-mm Mosin-Nagant Bolt Action Rifles and Carbines

| Characteristics                                  | Rifle M1891               | Dragoon rifle M1891       | Rifle M1891/30           | Sniper rifle M1891/30     | Carbine M1910             | Carbine M1938            | Carbine M1944                           |
|--|---------------------------|---------------------------|--------------------------|---------------------------|---------------------------|--------------------------|---|
| Weight, w/o bayonet & sling<br>w/bayonet & sling | 9.63 lb.<br>10.63 lb.     | 8.75 lb.<br>9.7 lb.       | 8.7 lb.<br>9.7 lb.       | 11.3 lb.<br>.....         | 7.5 lb.<br>7.7 lb.        | 7.62 lb<br>.....         | .....<br>8.9 lb.                        |
| Length, w/o bayonet<br>w/bayonet                 | 51.37 in.<br>68.2 in.     | 48.75 in.<br>65.5 in.     | 48.5 in.<br>65.4 in.     | 48.5 in.<br>65.4 in.      | 40 in.<br>.....           | 40 in.<br>.....          | 40 in. (folded)<br>52.25 in. (extended) |
| Barrel length                                    | 31.6 in.                  | 28.8 in.                  | 28.7 in.                 | 28.7 in.                  | 20 in.                    | 20 in.                   | 20.4 in.                                |
| Magazine capacity                                | 5 rounds                  | 5 rounds                  | 5 rounds                 | 5 rounds                  | 5 rounds                  | 5 rounds                 | 5 rounds                                |
| Instrumental velocity at 78 ft. w/hvy ball       | 2,660 f.p.s.              | 2,660 f.p.s.              | 2,660 f.p.s.             | 2,660 f.p.s.              | 2,514 f.p.s.              | 2,514 f.p.s.             | 2,514 f.p.s.                            |
| Rate of fire                                     | 8 - 10 rds./min.          | 8 - 10 rds./min.          | 8 - 10 rds./min.         | 8 - 10 rds./min.          | 8 - 10 rds./min.          | 8 - 10 rds./min.         | 8 - 10 rds./min.                        |
| Maximum sighting range                           | 3,200 arshins (2,496 yd.) | 3,200 arshins (2,496 yd.) | 2,000 meters (2,200 yd.) | 2,000 meters* (2,200 yd.) | 2,000 arshins (1,560 yd.) | 1,000 meters (1,100 yd.) | 1,000 meters (1,100 yd.)                |
| Front sight                                      | Unprotected blade         | Unprotected blade         | Hooded post              | Hooded post               | Unprotected blade         | Hooded post              | Hooded post                             |
| Rear sight                                       | Leaf                      | Leaf                      | Tangent                  | Tangent                   | Leaf                      | Tangent                  | Tangent                                 |
| Ammunition                                       | **                        | **                        | **                       | **                        | **                        | **                       | **                                      |

\*For iron sights when scope is dismounted. Maximum sighting range for the telescopic sight on this weapon is: PE scope: 1,400 meters (1,540 yd.); PU scope: 1,300 meters (1,420 yd.).

\*\*Soviet 7.62-mm rifle and ground machinegun ammunition.

SECTION II. DIFFERENCES BETWEEN MODELS

9. RIFLE M1991

The rifle M1991 (fig. 1) is the basic bolt action model. Later bolt action rifle and carbine models are variations and attempted improvements of the M1991.

a. This rifle has a notched-ramp leaf-type rear sight (fig. 2) which has no provision for windage. The sight is graduated from 400 to 9,200 meters (437 to 1,000 yards).

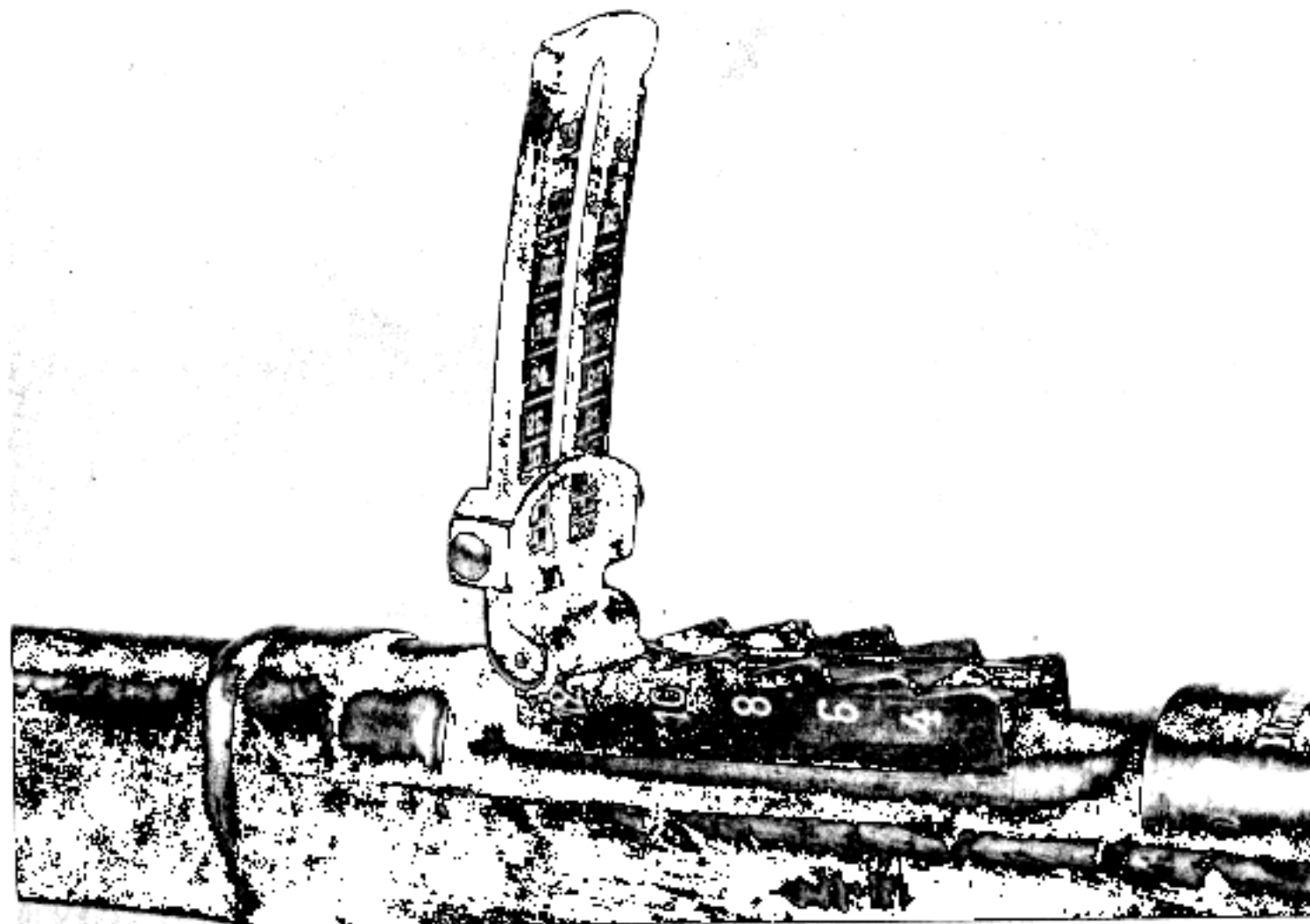

FIGURE 2. REAR SIGHT FOR RIFLE M1991.

b. The front sight is the unprotected blade type of sight.

c. The detachable fluted bayonet (fig. 3), with an effect sleeve for the barrel, is fastened to the rifle by a locking ring.

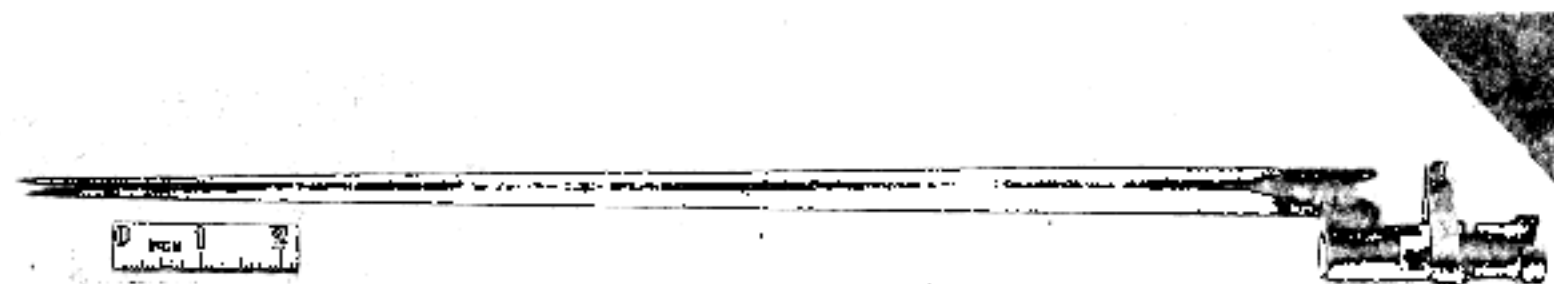

FIGURE 3. BAYONET FOR RIFLE M1991.



d. The two stock bands (fig. 10) are screw expanded (turn to the right to expand and to the left to close). The upper band is at the forward end of the handguard (fig. 11). The lower band is 2 inches forward of the rear sight.

e. The interrupter-ejector is one piece; it is illustrated in figure 12.

f. This rifle has a hexagonal receiver.

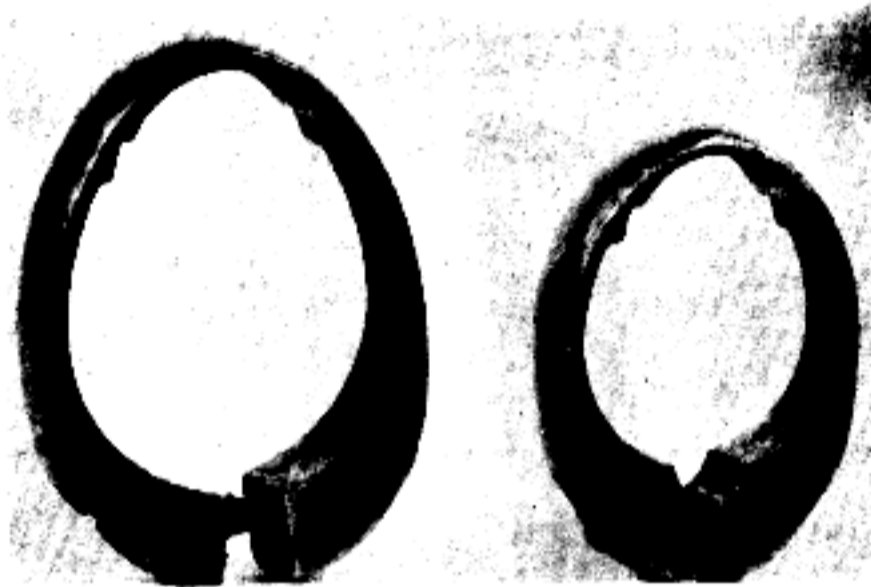

FIGURE 10. STOCK BANDS FOR RIFLE M1891.



FIGURE 11. LOCATION OF UPPER BAND ON RIFLE M1891.



FIGURE 12. INTERRUPTER-EJECTOR FOR RIFLE M1891.

#### 10. DRAGOON RIFLE M1891

a. The Dragoon rifle M1891 is shorter than the rifle M1891.

b. The front and rear sights are the same as those of the rifle M1891 (par. 9a and b).

c. The bayonet is the same as that of the rifle M1891 (par. 9c).

d. The Dragoon rifle M1891 has solid stock bands (fig. 13). The upper band is placed about 3-1/2 inches from the front end of the stock (fig. 14).



SOVIET RIFLES AND CARBINES  
IDENTIFICATION AND OPERATION

ORDI 7-101

May 1954

- e. The interrupter-ejector is the same as that of the rifle M1891 (par. 9e).
- f. This rifle has a hexagonal receiver.

11. CARBINE M1910

- a. This weapon is a short rifle, or carbine. It is basically a cut-down version of the rifle M1891. The M1910 is 40 inches in length (about 11 inches shorter than the rifle M1891).
- b. The carbine M1910 has almost a full stock.
- c. The leaf-type rear sight (fig. 15) is graduated from 400 to 2,000 arshins (312 yards to 1,560 yards).
- d. The front sight is the unprotected blade type.
- e. This weapon does not take a bayonet.
- f. The stock bands are solid.
- g. The interrupter-ejector is the same as that of the rifle M1891 (par. 9e).
- h. This carbine has a hexagonal receiver.

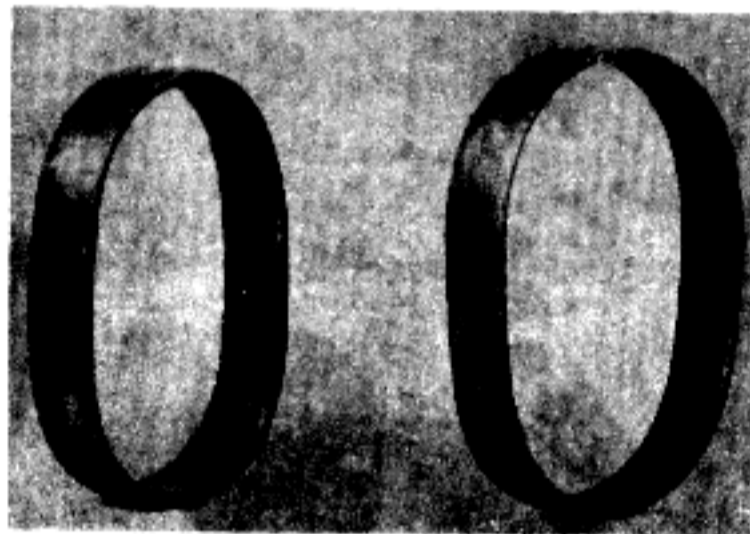

FIGURE 13. STOCK BANDS FOR DRAGOON RIFLE M1891.

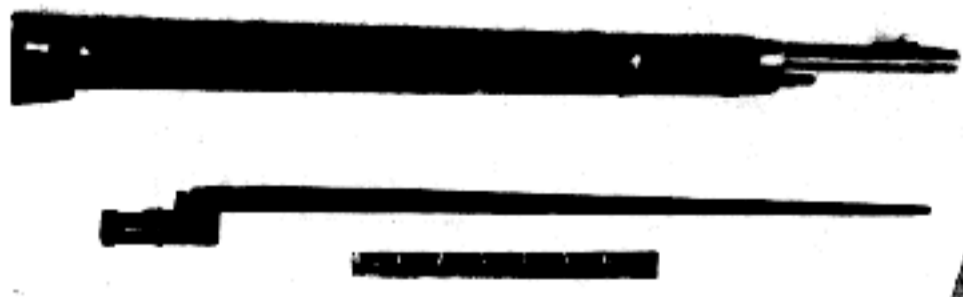

FIGURE 14. LOCATION OF UPPER BAND ON DRAGOON RIFLE M1891.

SOVIET RIFLES AND CARBINES  
IDENTIFICATION AND OPERATION

May 1954

ORDI 7-101

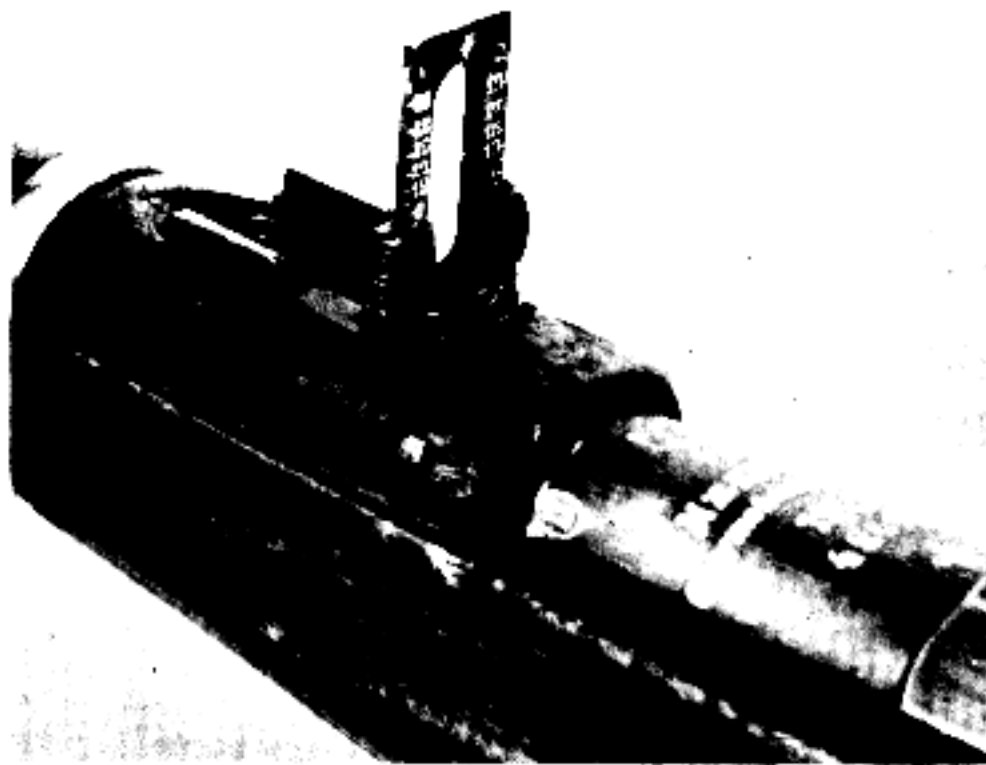

FIGURE 15. REAR SIGHT FOR CARBINE M1910.

12. RIFLE M1891/30

a. The rifle M1891/30 is about the same length as the Dragoon rifle M1891 and 2.8 inches shorter than the rifle M1891.

b. The weapon has a curved-ramp tangent-type rear sight (fig. 16). There is no provision for windage adjustment. The sight is graduated from 1 to 20; that is, for ranges of 100 meters to 2,000 meters (fig. 17). The relationship between meters and yards is given below:

| Meters | Yards | Meters | Yards |
|--------|-------|--------|-------|
| 100    | 110   | 1,100  | 1,200 |
| 200    | 220   | 1,200  | 1,300 |
| 300    | 330   | 1,300  | 1,420 |
| 400    | 440   | 1,400  | 1,530 |
| 500    | 550   | 1,500  | 1,670 |
| 600    | 660   | 1,600  | 1,750 |
| 700    | 770   | 1,700  | 1,860 |
| 800    | 880   | 1,800  | 1,970 |
| 900    | 990   | 1,900  | 2,080 |
| 1,000  | 1,100 | 2,000  | 2,200 |

c. The rifle M1891/30 has a hooded post-type front sight (fig. 18).

d. The bayonet (fig. 19) is fastened to the rifle by means of a spring-loaded catch, but is otherwise similar to the bayonet of the rifle M1891.

e. The two stock bands are of the split-ring type (fig. 20).

f. The two-piece interrupter-ejector for the rifle M1891/30 is illustrated in figure 21.

g. This rifle has a round receiver.

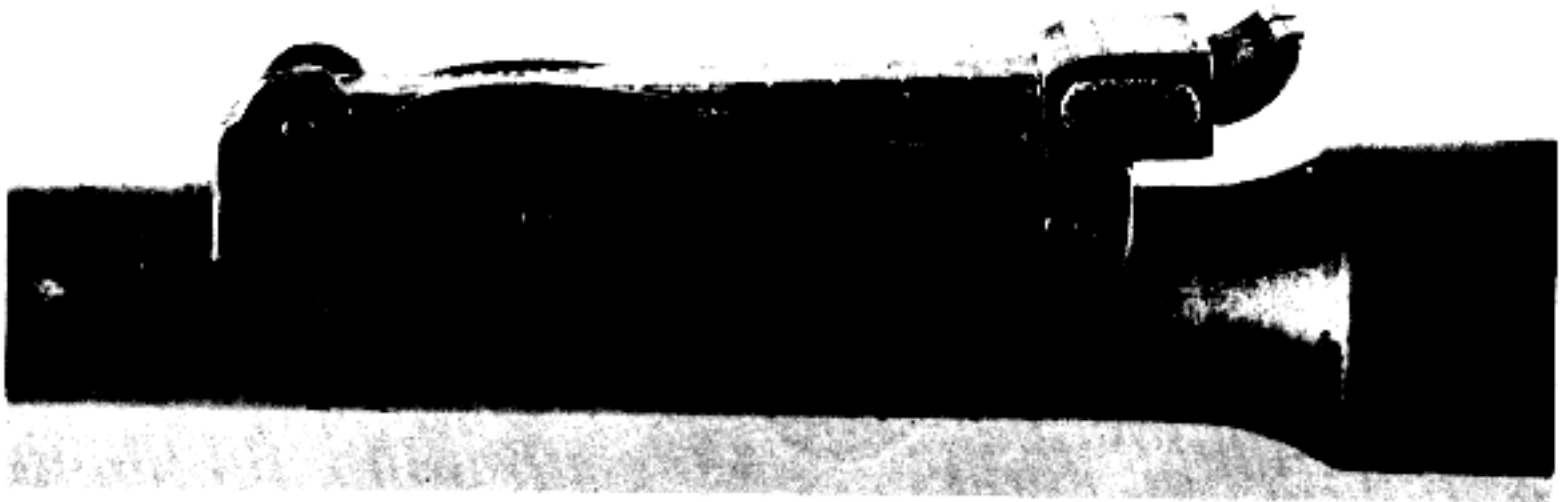

FIGURE 16. REAR SIGHT FOR RIFLE M1891/30 (SIDE VIEW).

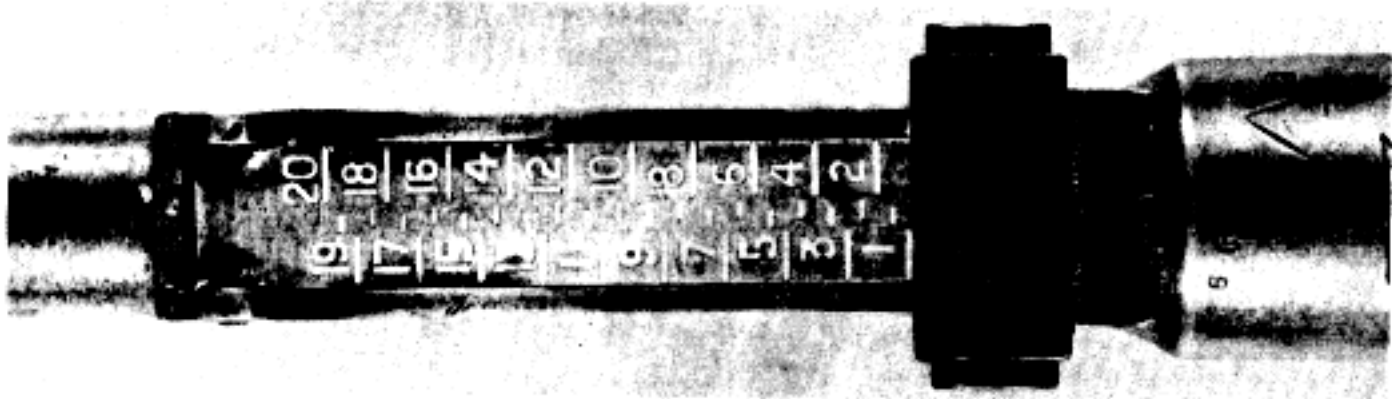

FIGURE 17. REAR SIGHT FOR RIFLE M1891/30 (TOP VIEW).

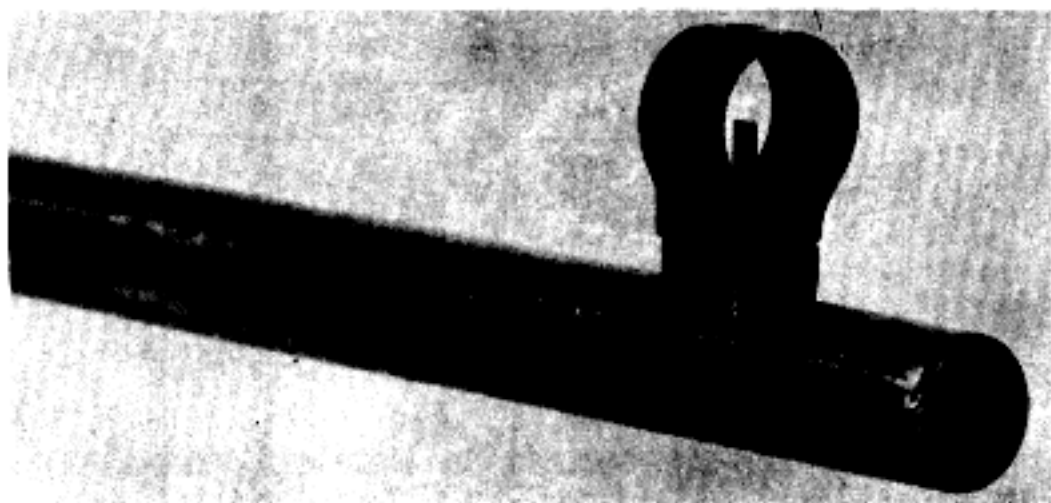

FIGURE 18. FRONT SIGHT FOR RIFLE M1891/30.

SOVIET RIFLES AND CARBINES  
IDENTIFICATION AND OPERATION

May 1954

ORDI 7-101

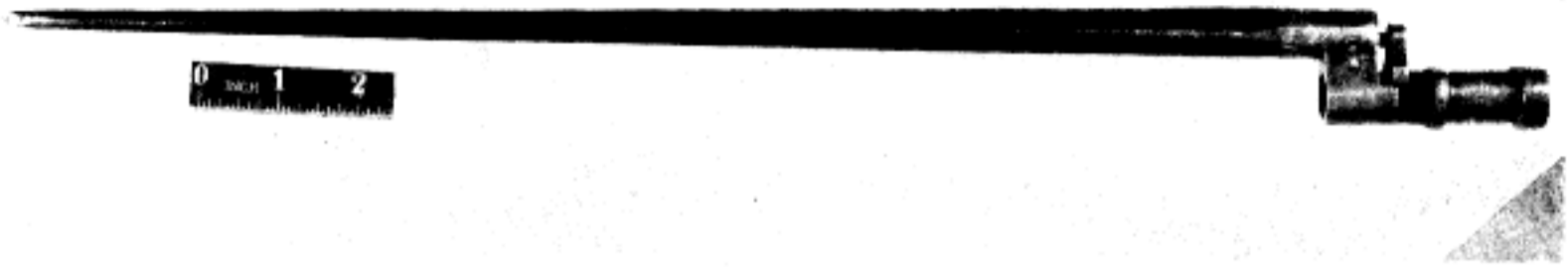

FIGURE 19. BAYONET FOR RIFLE M1891/30.

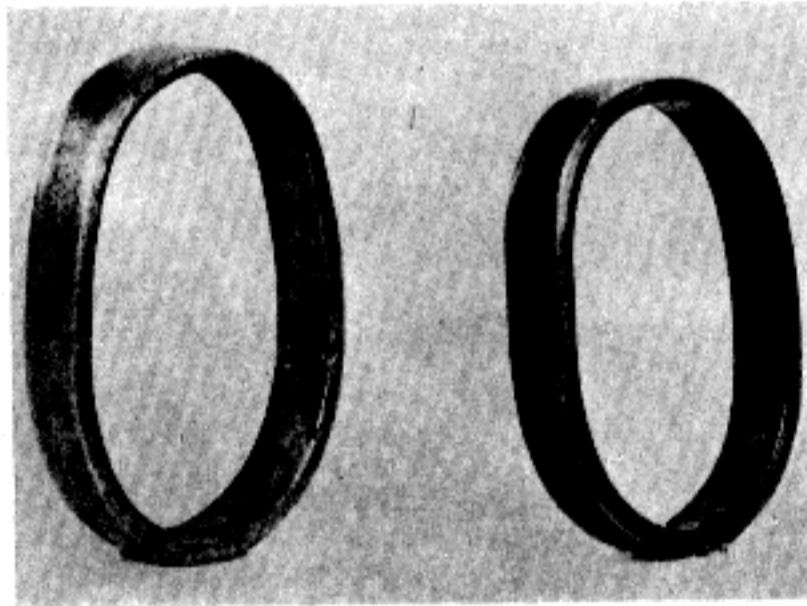

FIGURE 20. STOCK BANDS FOR RIFLE M1891/30.

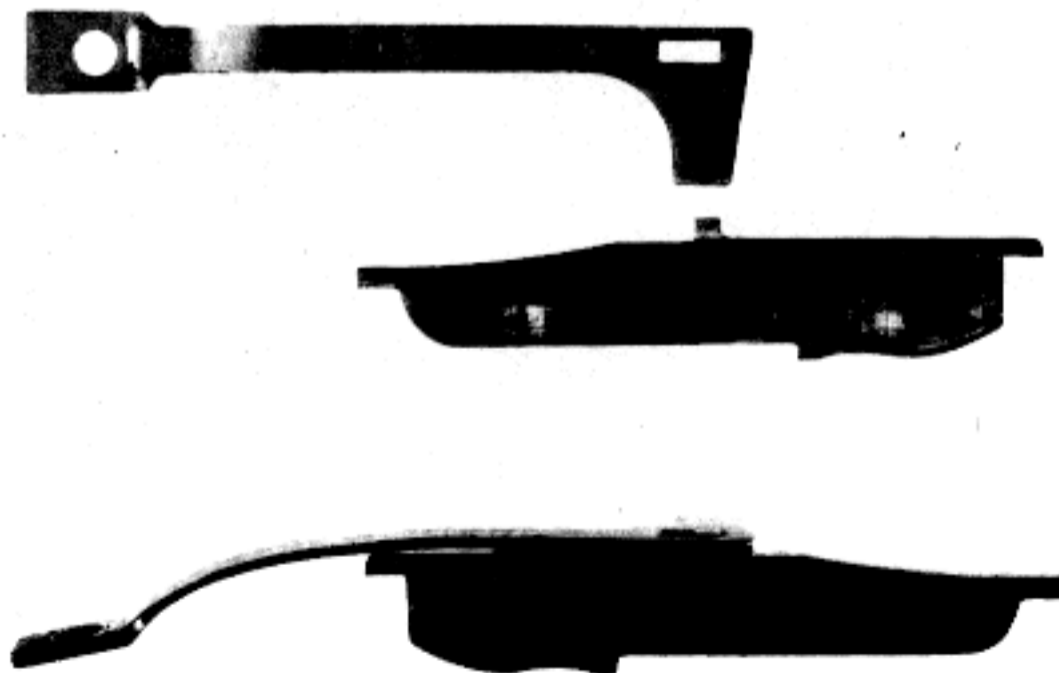

FIGURE 21. TWO-PIECE INTERRUPTER-EJECTOR FOR RIFLE M1891/30.

SOVIET RIFLES AND CARBINES  
IDENTIFICATION AND OPERATION

ORDI 7-101

May 1954

13. SNIPER RIFLE M1891/30

a. The sniper rifle M1891/30 is almost identical in appearance to the rifle M1891/30; however, it has been selected specially for its accuracy, and has been adapted for use with telescopes.

b. The bolt handle has been lengthened and bent down to prevent interference with the telescope (fig. 22).

c. Additional machining and tapping on the receiver of the sniper rifle M1891/30 permits the installation of three different types of mounts and telescopes. The different types of telescopes and mounts used on the sniper rifles are illustrated in figures 23 through 30.



FIGURE 22. SNIPER RIFLE (MODEL OF TELESCOPE AND MOUNT UNKNOWN).

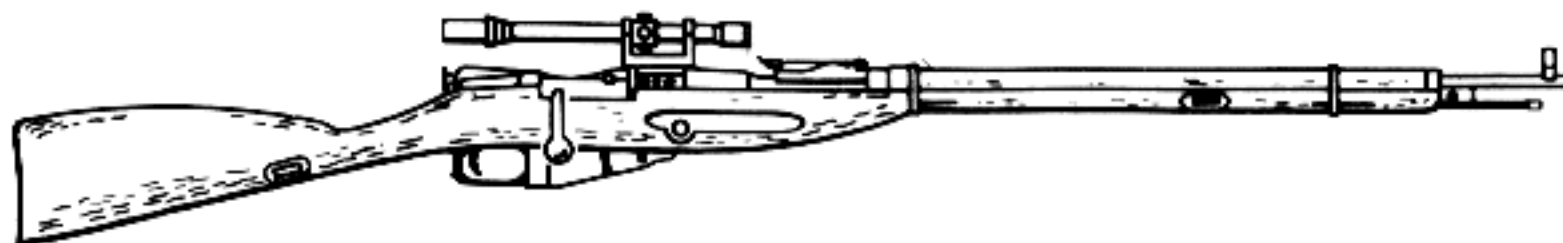

FIGURE 23. SNIPER RIFLE WITH PE TELESCOPE AND MOUNT.

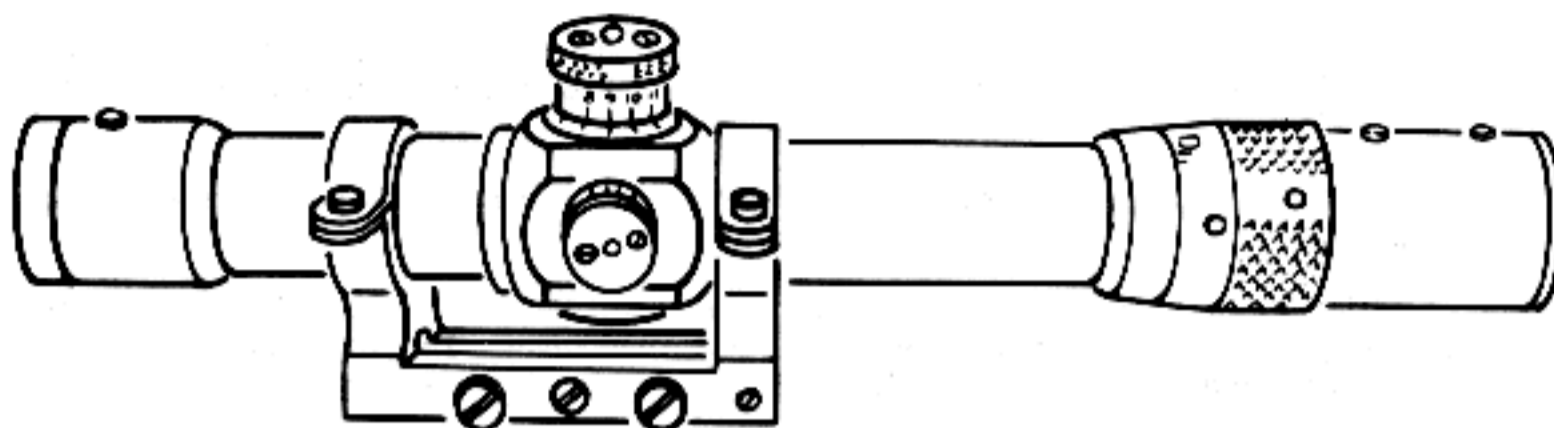

FIGURE 24. MODEL PE TELESCOPE, WITH BODY OF MOUNT.

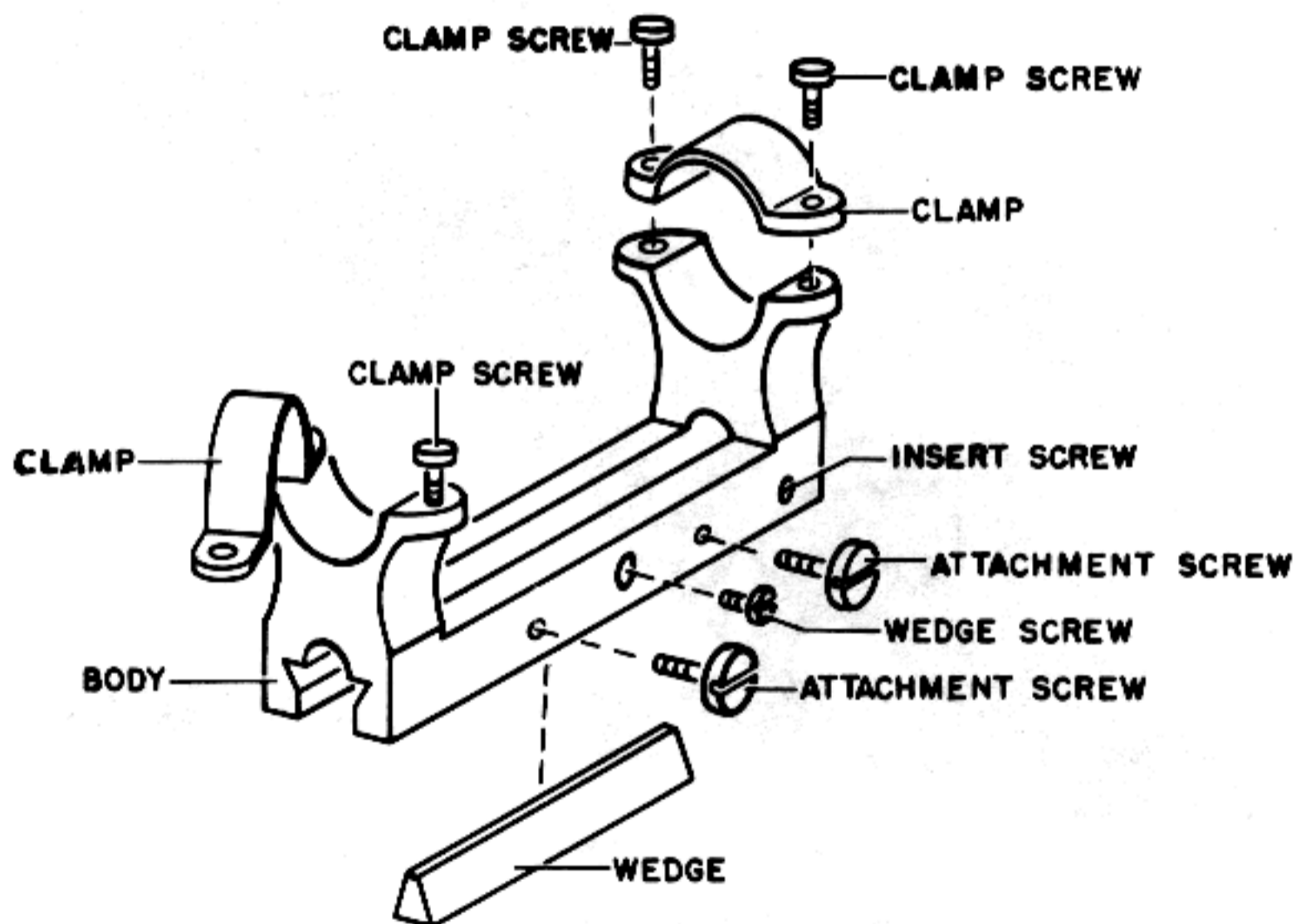
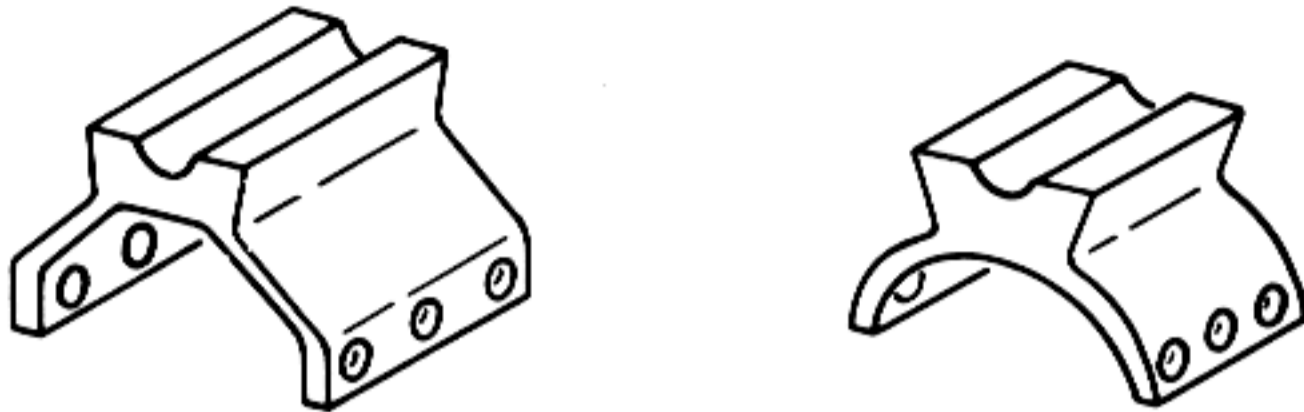

FIGURE 25. BODY OF PE TELESCOPE MOUNT.



FOR THE HEXAGONAL-SHAPED RECEIVER      FOR THE ROUND-TYPE RECEIVER

FIGURE 26. BASE OF PE TELESCOPE MOUNT.

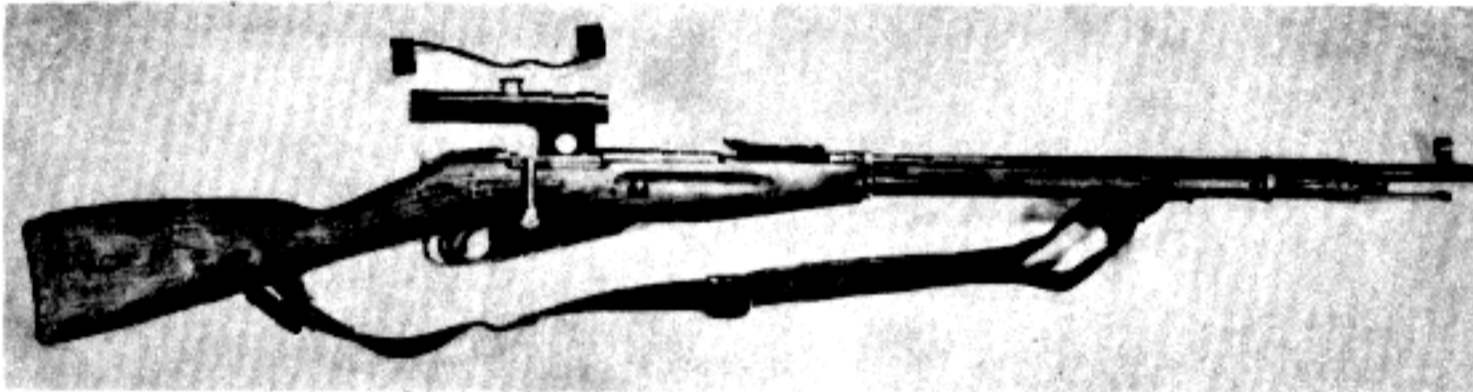

FIGURE 27. SNIPER RIFLE WITH PU TELESCOPE AND MOUNT (RIGHT SIDE).

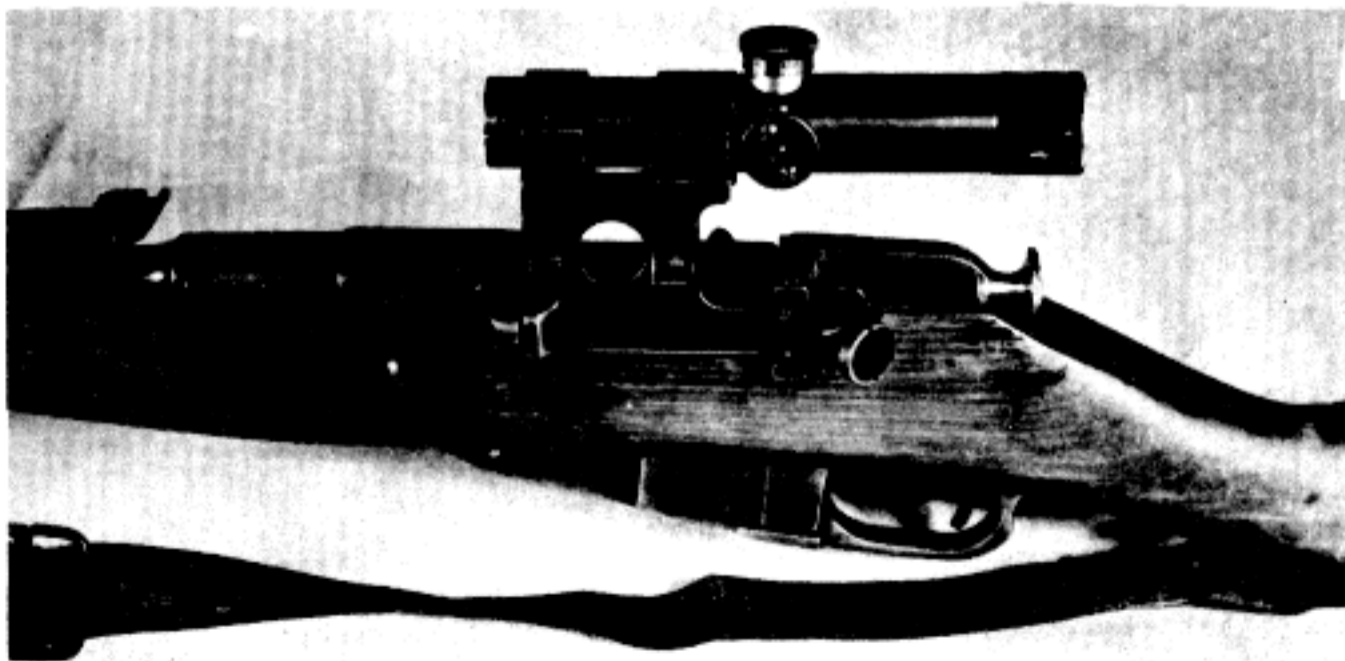

FIGURE 28. SNIPER RIFLE WITH PU TELESCOPE AND MOUNT (LEFT SIDE).



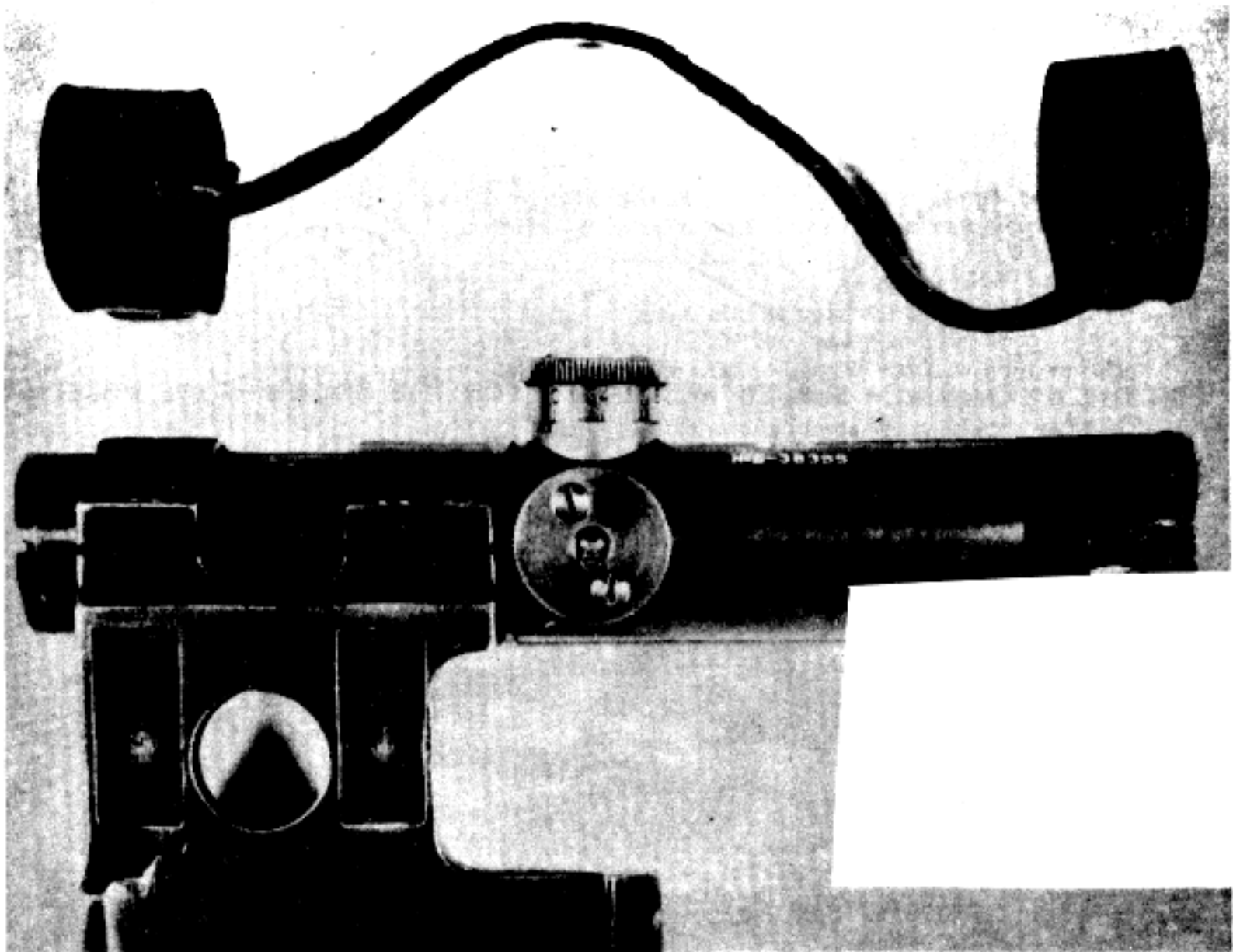

FIGURE 29. PU MOUNT AND TELESCOPE (LEFT SIDE VIEW).

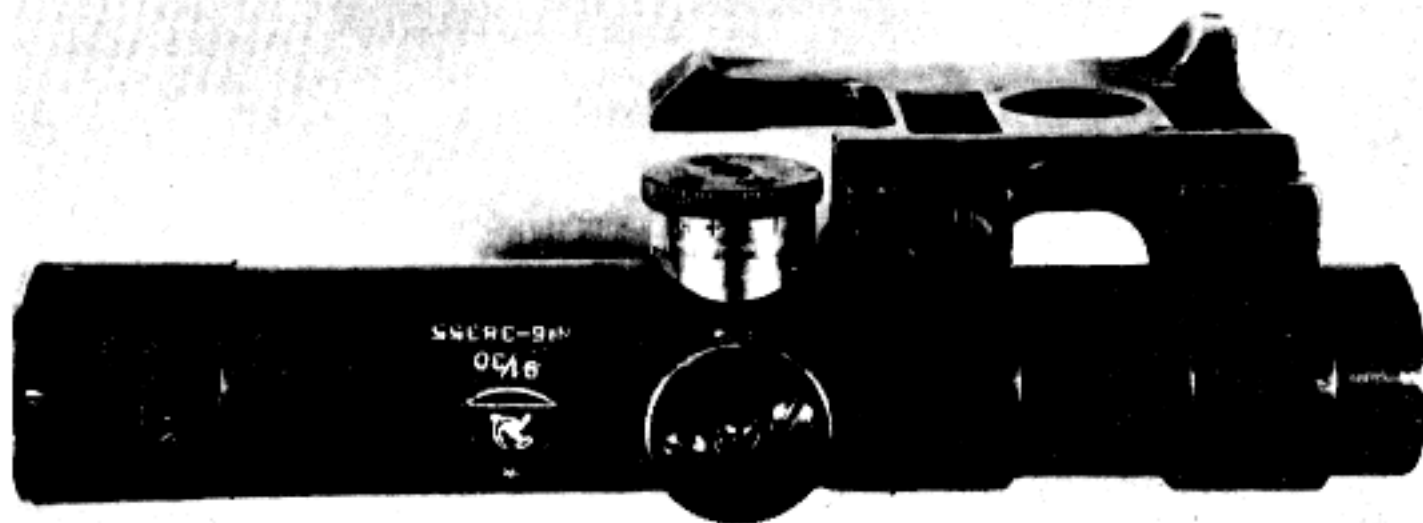

FIGURE 30. PU MOUNT AND TELESCOPE (TOP VIEW).

## 14. CARBINE M1938

a. The carbine M1938 is a cut-down version of the rifle M1891/30 and, until the introduction of the carbine M1944, replaced it as an arm of troops other than infantry and cavalry. The carbine M1938 is the same length as the carbine M1910 (40 inches).

b. The rear ramp sight (fig. 31) is similar to the rear ramp sight of the rifle M1891/30, except that it is shorter and is graduated from 100 meters to 1,000 meters (110 yards to 1,100 yards).

c. The front sight is the hooded post type.

d. The weapon will not accommodate any of the Soviet bayonets.

e. The two stock bands are of the split-ring type.

f. The two-piece interrupter-ejector is the same as that of the rifle M1891/30.

g. This carbine has a round receiver.

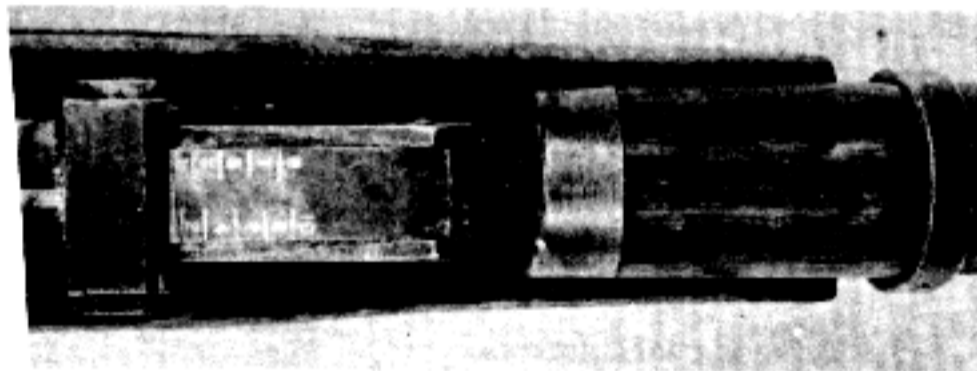

FIGURE 31. REAR RAMP SIGHT FOR CARBINE M1938.

## 15. CARBINE M1944

The carbine M1944 is identical to the M1938, except that it has a slightly longer barrel, carries a nondetachable folding bayonet (fig. 32), and the right side of the stock is modified slightly in order to accommodate the bayonet in the folded position. When the bayonet is folded, the M1944 is the same length as the carbine M1938 (40 inches); with the bayonet extended, it is 52.25 inches in length.



FIGURE 32. BAYONET FOR CARBINE M1944.

## SECTION III. INTERCHANGEABILITY

## 16. COMPONENTS INTERCHANGEABLE BETWEEN ALL MODELS

a. While many of the component parts are interchangeable between all Mosin-Nagant bolt action rifles and carbines, these weapons function more efficiently with their original components. Each component is stamped with the serial number of the original weapon and, if possible, should be used with that weapon; this applies even to individual weapons of the same models.

b. The following components are interchangeable between all Mosin-Nagant bolt action rifles and carbines:

- (1) Bolts and bolt assemblies (except that the bolt body of other models can not be used in the sniper rifle M1891/30).
- (2) Trigger assemblies.
- (3) Interrupter-ejectors (both one- and two-piece).
- (4) Magazines and magazine assemblies.
- (5) Front sights.
- (6) Butt plates and screws.
- (7) Stock bands and retaining springs.
- (8) Trigger guard screws.

## 17. COMPONENTS INTERCHANGEABLE BETWEEN SPECIFIED MODELS

Handguards, stocks, rear sights, and bayonets are interchangeable between certain Mosin-Nagant models, as cited below.

a. Rifle M1891. The following parts of the weapons specified can be used on the rifle M1891.

- (1) The stock of the Dragoon rifle M1891, rifle M1891/30, or sniper rifle M1891/30.
- (2) The rear sight of the Dragoon rifle M1891.
- (3) The bayonet of the Dragoon rifle M1891, rifle M1891/30, or sniper rifle M1891/30.

b. Dragoon rifle M1891. The following parts of the weapons specified can be used on the Dragoon rifle M1891.

- (1) The handguard of the rifle M1891/30 or sniper rifle M1891/30.
- (2) The stock of the rifle M1891/30 or sniper rifle M1891/30. (The stock of the M1891 also can be used, but will prevent attaching the bayonet.)
- (3) The rear sight of the rifle M1891.
- (4) The bayonet of the rifle M1891, rifle M1891/30, or sniper rifle M1891/30.

## SOVIET RIFLES AND CARBINES

### IDENTIFICATION AND OPERATION

ORDI 7-101

May 1954

c. Carbine M1910. The stock of the carbine M1938 or M1944 can be used on the M1910.

d. Rifle M1891/30. The following parts of the weapons specified can be used on the M1891/30.

- (1) The handguard of the Dragoon M1891 or sniper rifle M1891/30.
- (2) The stock of the Dragoon M1891 or sniper rifle M1891/30. (The stock of the rifle M1891 also can be used, but will prevent attaching the bayonet.)
- (3) The bayonet of the sniper rifle M1891/30.

e. Sniper rifle M1891/30. The following parts of the weapons specified can be used on the sniper rifle M1891/30.

- (1) The stock of the Dragoon rifle M1891 or rifle M1891/30. (The stock of the rifle M1891 also can be used, but will prevent attaching the bayonet.)

NOTE: If the PU telescope mount is to be used, these stocks must be cut away so that the mount may rest flush against the receiver. (Use of the unidentified sight mount shown in figure 22 may likewise necessitate cutting away part of the stock.)

- (2) The bayonet of the rifle M1891/30.

f. Carbine M1938. The following parts of the weapons specified can be used on the carbine M1938.

- (1) The handguard of the carbine M1944.
- (2) The stock of the carbine M1910 or M1944.
- (3) The rear sight of the carbine M1944.

g. Carbine M1944. The following parts of the weapons specified can be used on the carbine M1944.

- (1) The handguard of the carbine M1938.
- (2) The rear sight of the carbine M1938.

### SECTION IV. AMMUNITION

#### 18. DESCRIPTION

Standard Soviet rifle ammunition (fig. 33) is of 7.62-mm caliber (cal. .30), has a rimmed bottlenecked case, and is 3.03 inches in length. Ground machinegun ammunition, which is identical in appearance except for color markings, may be used in rifles and carbines; however, only the light ball M1908 and heavy ball M1930 are recommended for this purpose by the Soviet Army. No color marking is found on the ammunition for the light bullet M1908. The heavy bullet M1930 has a yellow tip.

NOTE: ShKAS aircraft machinegun ammunition should not be used in rifles since it may damage the extractor. ShKAS ammunition can be identified by the Russian symbol III (Sh) stamped on the base; in addition to the stamped symbol, ShKAS rounds sometimes have red shellac coloring on the primer.

SOVIET RIFLES AND CARBINES  
IDENTIFICATION AND OPERATION

ORDI 7-101

May 1954

- c. Carbine M1910. The stock of the carbine M1938 or M1944 can be used on the M1910.
- d. Rifle M1891/30. The following parts of the weapons specified can be used on the M1891/30.
- (1) The handguard of the Dragoon M1891 or sniper rifle M1891/30.
  - (2) The stock of the Dragoon M1891 or sniper rifle M1891/30. (The stock of the rifle M1891 also can be used, but will prevent attaching the bayonet.)
  - (3) The bayonet of the sniper rifle M1891/30.
- e. Sniper rifle M1891/30. The following parts of the weapons specified can be used on the sniper rifle M1891/30.
- (1) The stock of the Dragoon rifle M1891 or rifle M1891/30. (The stock of the rifle M1891 also can be used, but will prevent attaching the bayonet.)
- NOTE: If the PU telescope mount is to be used, these stocks must be cut away so that the mount may rest flush against the receiver. (Use of the unidentified sight mount shown in figure 22 may likewise necessitate cutting away part of the stock.)
- (2) The bayonet of the rifle M1891/30.
- f. Carbine M1938. The following parts of the weapons specified can be used on the carbine M1938.
- (1) The handguard of the carbine M1944.
  - (2) The stock of the carbine M1910 or M1944.
  - (3) The rear sight of the carbine M1944.
- g. Carbine M1944. The following parts of the weapons specified can be used on the carbine M1944.
- (1) The handguard of the carbine M1938.
  - (2) The rear sight of the carbine M1938.

SECTION IV. AMMUNITION

18. DESCRIPTION

Standard Soviet rifle ammunition (fig. 33) is of 7.62-mm caliber (cal. .30), has a rimmed bottlenecked case, and is 3.03 inches in length. Ground machinegun ammunition, which is identical in appearance except for color markings, may be used in rifles and carbines; however, only the light ball M1908 and heavy ball M1930 are recommended for this purpose by the Soviet Army. No color marking is found on the ammunition for the light bullet M1908. The heavy bullet M1930 has a yellow tip.

NOTE: ShKAS aircraft machinegun ammunition should not be used in rifles since it may damage the extractor. ShKAS ammunition can be identified by the Russian symbol III (Sh) stamped on the base; in addition to the stamped symbol, ShKAS rounds sometimes have red shellac coloring on the primer.

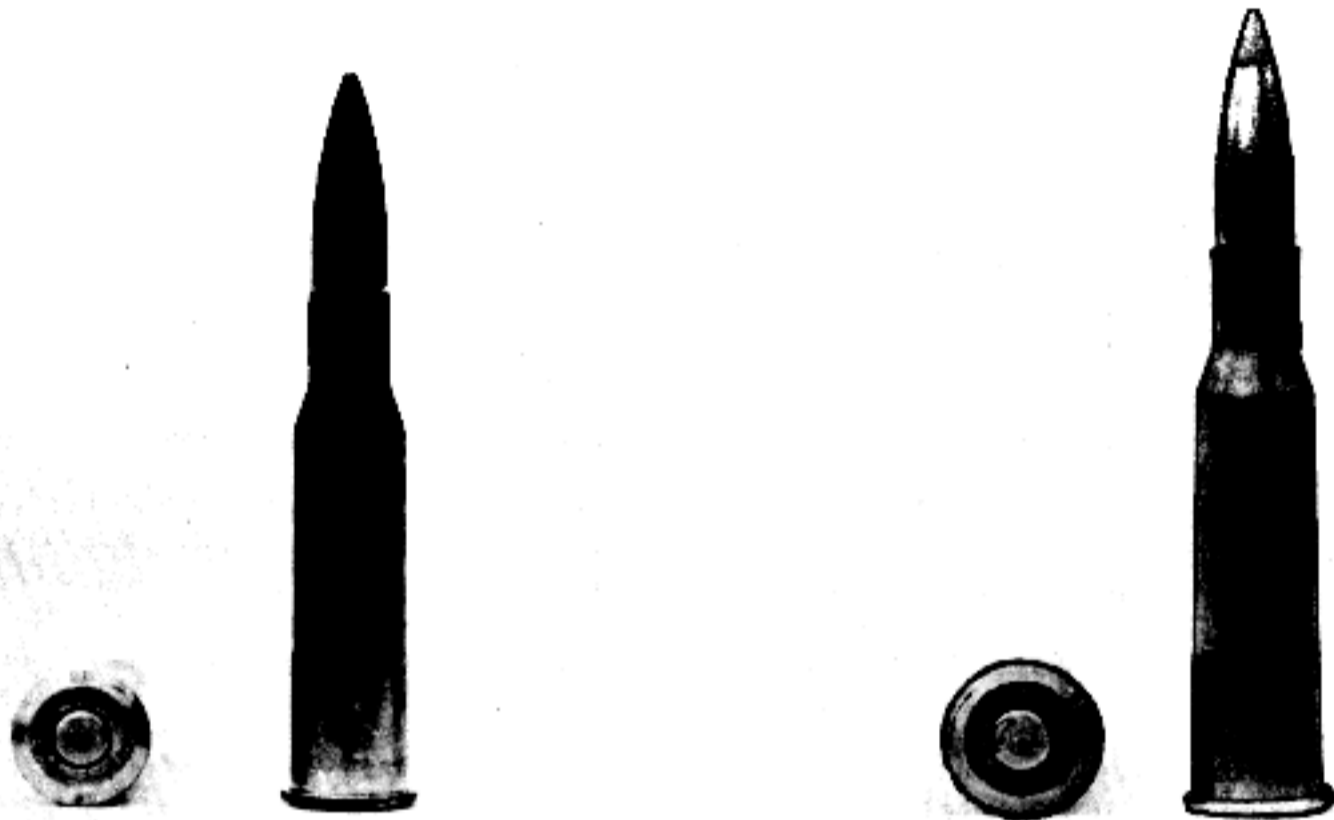

FIGURE 33. SOVIET RIFLE AMMUNITION (LIGHT BALL ON LEFT, HEAVY BALL ON RIGHT).

#### 19. PACKAGING

Ammunition for rifles is usually packed in five-round clips (fig. 34), three clips to a cardboard package, twenty packages to a hermetically sealed zinc-coated metal container (a total of 300 cartridges), and two metal containers to a wooden box (a total of 600 cartridges). The wooden boxes are marked as illustrated in figure 35. Rifle ammunition also may be packed in twenty-round packages tied with a string or tape; twenty-two such packages are hermetically sealed in a metal container (a total of 440 cartridges), and two metal containers are then packed in a wooden box (a total of 880 cartridges). Machinegun ammunition is packed in this same manner. There are no color markings on the packaging of the light bullet M1908; however, the heavy bullet M1930 has a yellow stripe on both the inner metal and the outer wooden packing boxes.

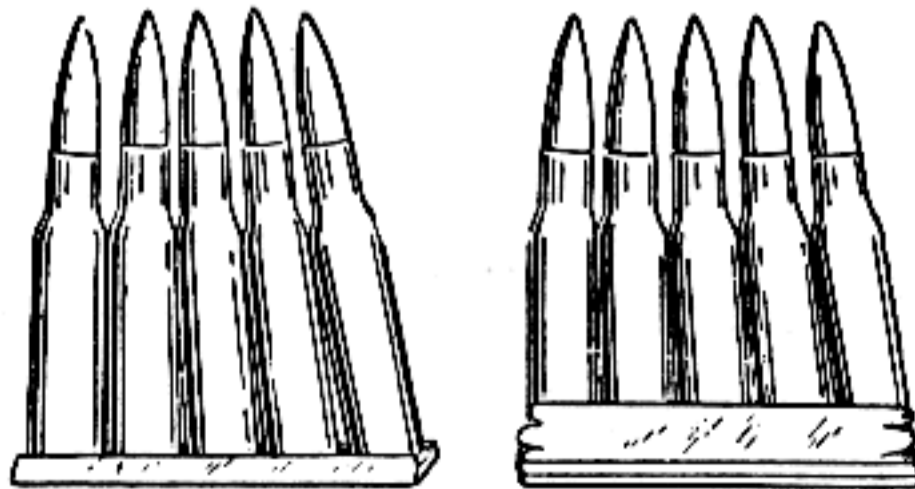

FIGURE 34. SOVIET FIVE-ROUND CARTRIDGE CLIPS.



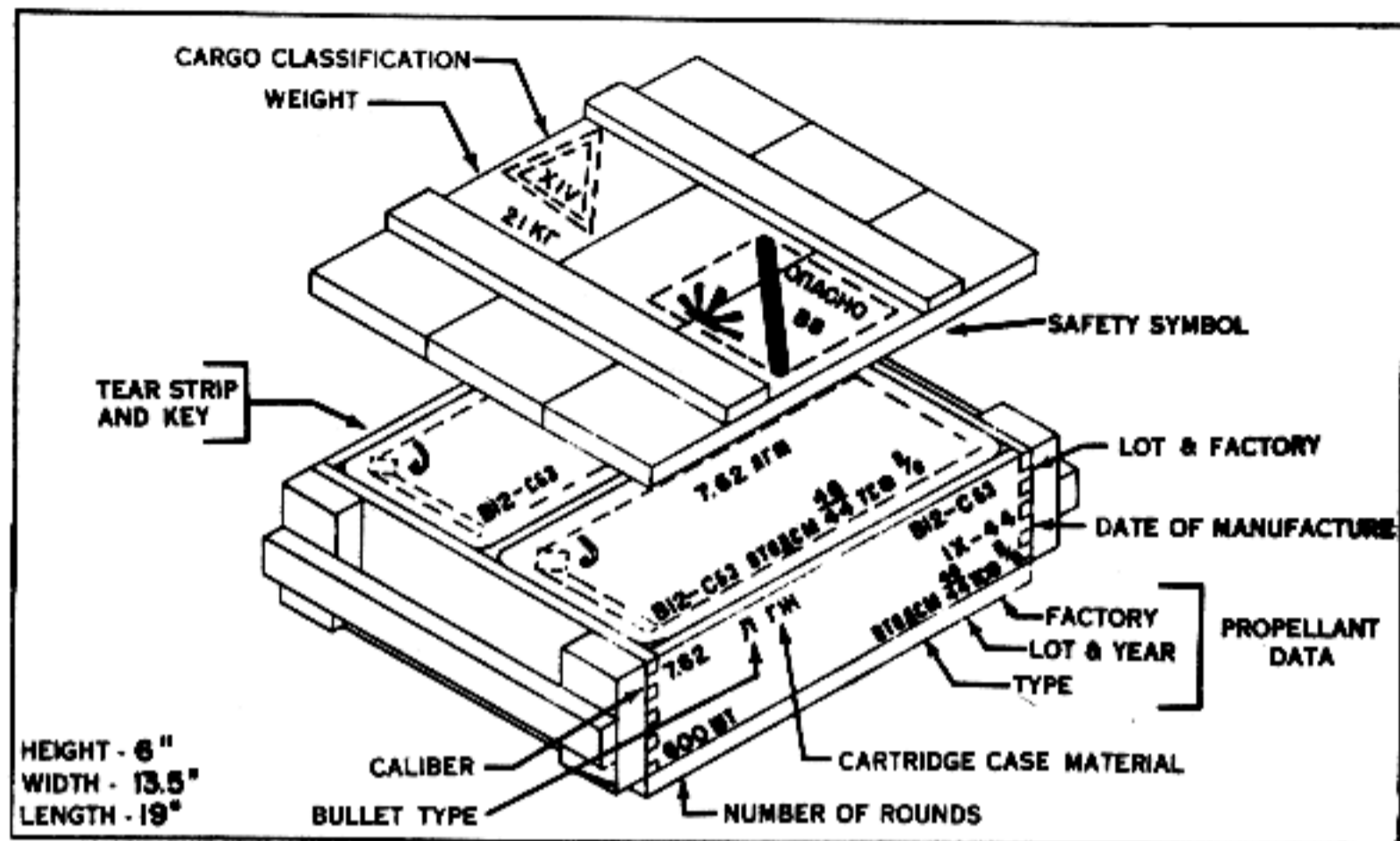

FIGURE 35. SOVIET AMMUNITION BOX.

SECTION V. SIGHTING EQUIPMENT

20. RIFLE M1891

The front sight is of the unprotected blade type and is dovetailed into the sight base, which is soldered to the barrel. The notched-ramp leaf-type rear sight (fig. 8) is graduated from 400 to 3,200 arshins (312 to 2,496 yards), but has no provisions for windage adjustment.

21. DRAGOON RIFLE M1891

The sighting equipment of this rifle is identical to that of the rifle M1891.

22. CARBINE M1910

The front sight is of the unprotected blade type and is identical to that of the rifle M1891. The leaf-type rear sight is graduated from 400 to 2,000 arshins (312 to 1,560 yards).

23. RIFLE M1891/30

The front sight (fig. 18) is a hooded post type and is dovetailed into the sight base, which is welded to the barrel. The curved-ramp tangent-type rear sight (fig. 17) is graduated from 100 to 2,000 meters (110 to 2,200 yards). There is no provision for windage adjustment.



SOVIET RIFLES AND CARBINES  
IDENTIFICATION AND OPERATION

ORDI 7-101

May 1954

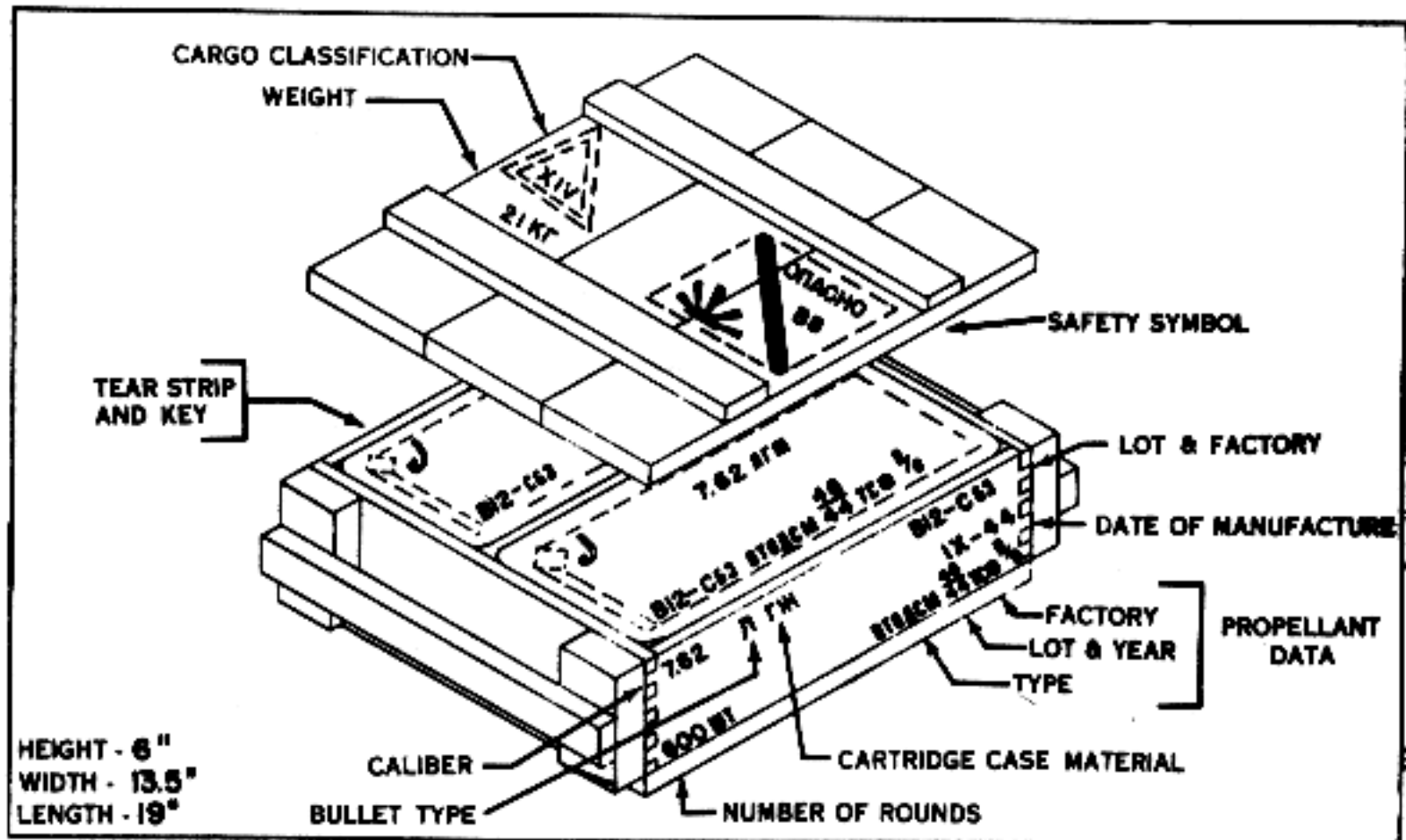

FIGURE 35. SOVIET AMMUNITION BOX.

SECTION V. SIGHTING EQUIPMENT

20. RIFLE M1891

The front sight is of the unprotected blade type and is dovetailed into the sight base, which is soldered to the barrel. The notched-ramp leaf-type rear sight (fig. 8) is graduated from 400 to 3,200 arshins (312 to 2,496 yards), but has no provisions for windage adjustment.

21. DRAGOON RIFLE M1891

The sighting equipment of this rifle is identical to that of the rifle M1891.

22. CARBINE M1910

The front sight is of the unprotected blade type and is identical to that of the rifle M1891. The leaf-type rear sight is graduated from 400 to 2,000 arshins (312 to 1,560 yards).

23. RIFLE M1891/30

The front sight (fig. 18) is a hooded post type and is dovetailed into the sight base, which is welded to the barrel. The curved-ramp tangent-type rear sight (fig. 17) is graduated from 100 to 2,000 meters (110 to 2,200 yards). There is no provision for windage adjustment.

## 24. SNIPER RIFLE M1891/30

a. The front and rear iron sights of this rifle are not removed when the telescope is attached, and are identical to those used on the rifle M1891/30. These sights may be used for ranges up to 700 meters (770 yards) without removing the telescope, when the rifle is equipped with the unidentified scope and mount shown in figure 22. The iron sights may be used up to 600 meters (660 yards) when the PE scope (fig. 23) is mounted, and up to 2,000 meters (2,200 yards) with the PU scope (fig. 27).

b. Basic characteristics of the PE and PU telescopes are given below:

| <u>Characteristics</u> | <u>PE scope</u> | <u>PU scope</u>  |
|------------------------|-----------------|------------------|
| Power                  | 4 <sup>x</sup>  | 3.5 <sup>x</sup> |
| Field of view          | 5° 30'          | 4° 30'           |
| Diameter of exit pupil | 0.273 in.       | 0.234 in.        |
| Eye relief*            | 3.24 in.        | 2.80 in.         |
| Length                 | 10.68 in.       | 6.59 in.         |
| Weight                 | 1.3 lb.         | 0.59 lb.         |

\*Eye relief is the distance from the eyepiece to the focal point.

c. External features of the PE and PU optical sights are given below:

- (1) A thumbscrew with sight graduations at 100-meter intervals is located on top of both telescopes. This thumbscrew is used for setting angles of elevation.
  - (a) In the PE system, the scale of graduations is from 1 to 14; therefore, the PE scope may be sighted from 100 to 1,400 meters (110 to 1,540 yards).
  - (b) In the PU system the scale of graduations is from 1 to 13; therefore, the PU scope may be sighted from 100 to 1,300 meters (110 to 1,420 yards).
- (2) A thumbscrew for lateral corrections (windage, drift, and in the case of a moving target, lead) is located on the left side of these telescopes. It has 10 graduations in either direction, beginning with zero; the plus markings are used for corrections to the right and the minus markings for corrections to the left. Each graduation is equal to one mil and only the 5th and 10th graduations are numbered.
- (3) On the tube of the PE sight there is a knurled collar with a diopter scale, to make adjustments for defects of vision. The plus markings on the scale are used to make adjustments for farsightedness, and the minus markings for nearsightedness. With the PU optical sight, such corrections are made by moving the eye nearer to or farther away from the eyepiece, until the optimum acuity of vision is achieved.

## 25. CARBINE M1938

The hooded post-type front sight of the carbine M1938 is very similar to the front sight of the rifle M1891/30, but is mounted on a barrel band. The curved-ramp tangent-type rear sight is also very similar in construction to that of the M1891/30; however, it is graduated from 100 to 1,000 meters (110 to 1,100 yards) (fig. 31).

## 26. CARBINE M1944

The front and rear sights of the carbine M1944 are identical to those of the carbine M1938.

## SECTION VI. OPERATING INSTRUCTIONS

## 27. RIFLE M1891

a. To set the safety, draw back the cocking piece and turn it to the left. This prevents the bolt from opening. To put off safe, pull the cocking piece back, turn it to the right, and allow it to move forward.

b. The rifle M1891 is loaded in the same manner as the United States Springfield or any Mauser rifle. Open the bolt, place a clip of cartridges in the clip guides, and press the rounds down into the magazine (fig. 36). Close the bolt; the clip will then fall out of the clip guides onto the ground. The position of the rifle parts before and after loading is illustrated in figures 37 and 38. Before squeezing the trigger, observe all the safety precautions used when firing United States rifles.

c. To unload the rifle M1891, open the magazine floor plate and remove the cartridges. The magazine floor plate catch is located on the lower rear part of the magazine, forward of the trigger guard. Press the catch rearward; the follower and floor plate (fig. 39) will swing down and forward on a pivot pin, and the cartridges will spill out. Open the bolt and extract the round from the chamber.

d. The M1891 bayonet (fig. 9) is attached by a locking ring; if the M1891/30 bayonet (fig. 19) is used, a spring-loaded catch holds the bayonet in place.

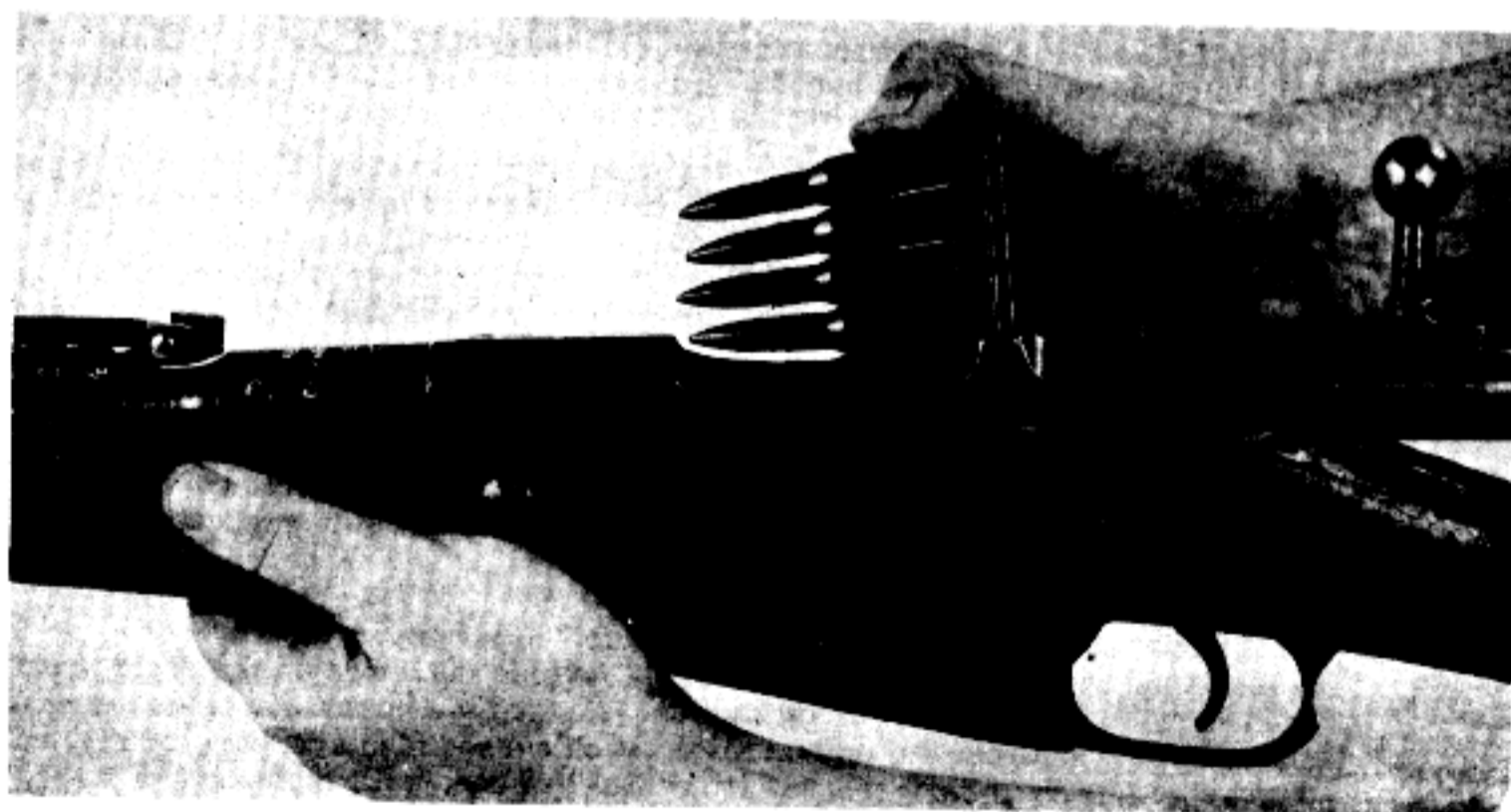

FIGURE 36. CLIP-LOADING THE RIFLE.

**26. CARBINE M1944**

The front and rear sights of the carbine M1944 are identical to those of the carbine M1938.

**SECTION VI. OPERATING INSTRUCTIONS****27. RIFLE M1891**

a. To set the safety, draw back the cocking piece and turn it to the left. This prevents the bolt from opening. To put off safe, pull the cocking piece back, turn it to the right, and allow it to move forward.

b. The rifle M1891 is loaded in the same manner as the United States Springfield or any Mauser rifle. Open the bolt, place a clip of cartridges in the clip guides, and press the rounds down into the magazine (fig. 36). Close the bolt; the clip will then fall out of the clip guides onto the ground. The position of the rifle parts before and after loading is illustrated in figures 37 and 38. Before squeezing the trigger, observe all the safety precautions used when firing United States rifles.

c. To unload the rifle M1891, open the magazine floor plate and remove the cartridges. The magazine floor plate catch is located on the lower rear part of the magazine, forward of the trigger guard. Press the catch rearward; the follower and floor plate (fig. 39) will swing down and forward on a pivot pin, and the cartridges will spill out. Open the bolt and extract the round from the chamber.

d. The M1891 bayonet (fig. 9) is attached by a locking ring; if the M1891/30 bayonet (fig. 19) is used, a spring-loaded catch holds the bayonet in place.

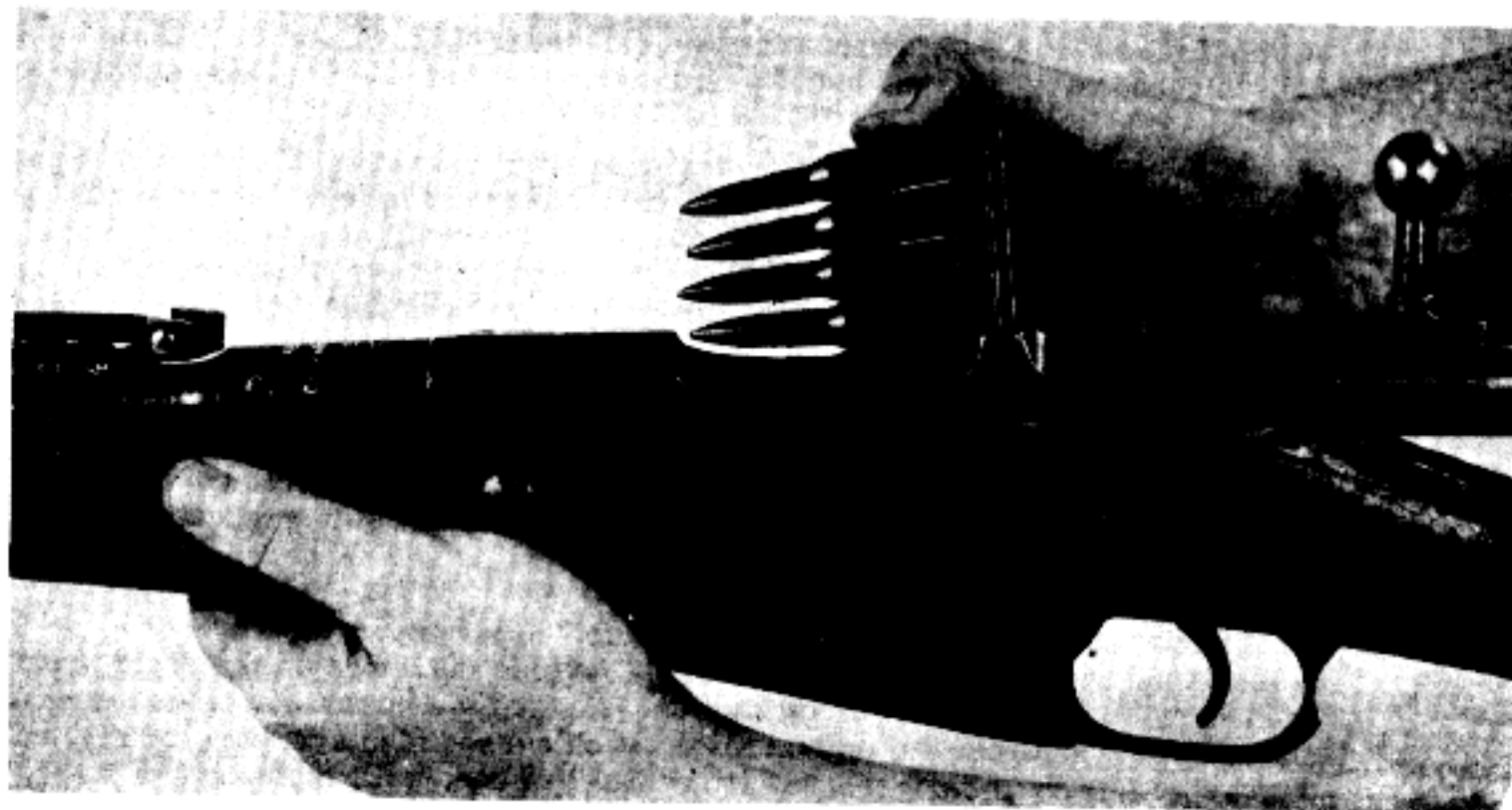

FIGURE 36. CLIP-LOADING THE RIFLE.

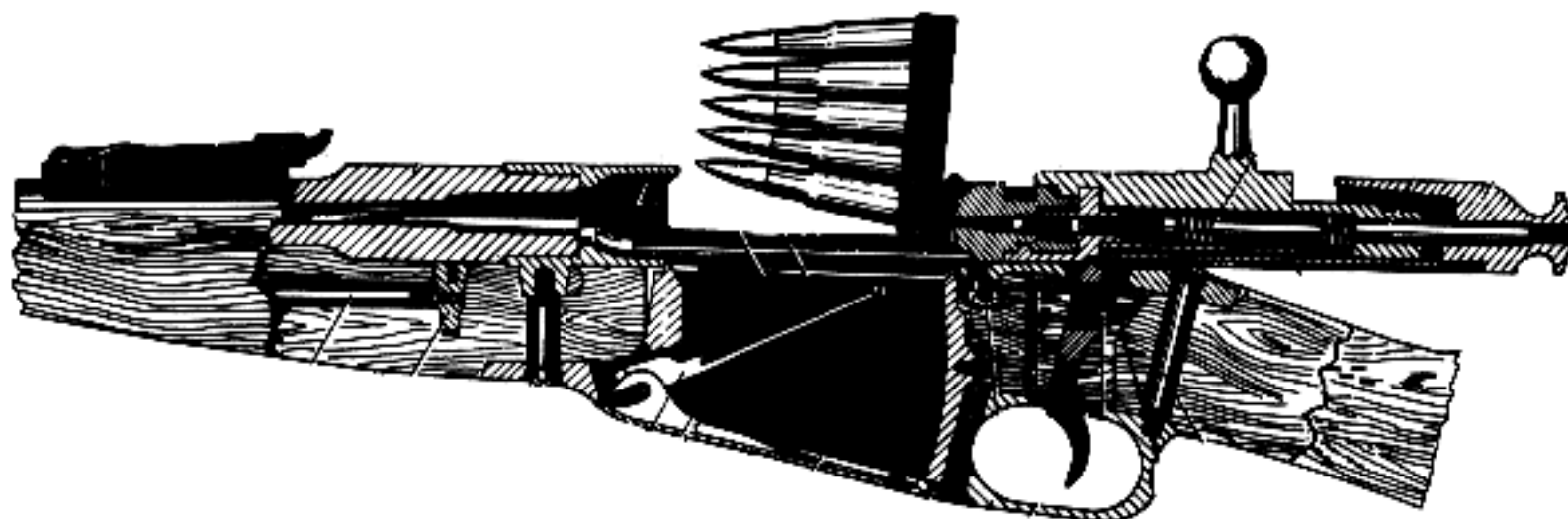

FIGURE 37. POSITION OF PARTS PRIOR TO LOADING THE RIFLE.

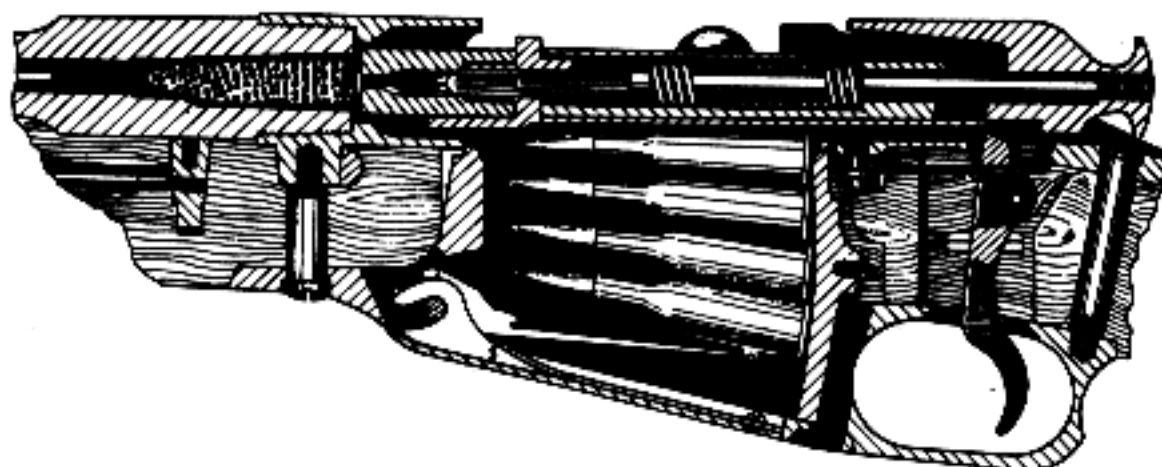

FIGURE 38. POSITION OF PARTS AFTER RIFLE IS LOADED.

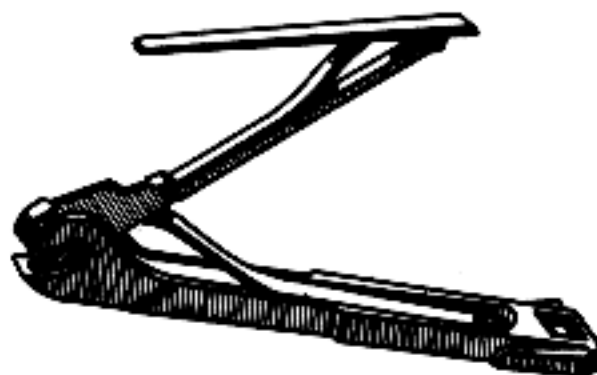

FIGURE 39. FOLLOWER AND FLOOR PLATE.

**28. DRAGOON RIFLE M1891**

a. Operating instructions for the Dragoon M1891 are the same as for the rifle M1891.

b. The bayonet of the rifle M1891 or M1891/30 is attached to the Dragoon M1891 in the same manner as described for the rifle M1891.

**29. CARBINE M1910**

Operating instructions for the carbine M1910 are the same as those for the rifle M1891; however, bayonets are not provided for this carbine.

SOVIET RIFLES AND CARBINES  
IDENTIFICATION AND OPERATION

ORDI 7-101

May 1954

30. RIFLE M1891/30

a. Operating instructions for the rifle M1891/30 are the same as those for the rifle M1891.

b. The bayonet is attached by means of a spring-loaded catch.

31. SNIPER RIFLE M1891/30

a. Operating instructions for this rifle are the same as those for the rifle M1891. The bayonet for the rifle M1891/30 is attached to the sniper rifle by means of a spring-loaded catch.

b. Instructions for operating the rifle telescopes are given in paragraph 24.

32. CARBINE M1938

Operating instructions for this carbine are the same as those for the rifle M1891; however, bayonets are not provided for this carbine.

33. CARBINE M1944

Operating instructions for this carbine are the same as those for the rifle M1891; however, this carbine has a nondetachable bayonet which may be folded or extended by forcing the spring-loaded bayonet tube away from the pivot pin and then swinging the bayonet to either marching or combat position.

SECTION VII. MAINTENANCE

34. ACCESSORIES

Each Mosin-Nagant bolt action rifle and carbine is provided with a one-piece cleaning rod (fig. 40) which is fitted in the stock. The rod is threaded on the end to take the tapped retaining nut embedded in the stock just below the chamber (fig. 37). An accessory pouch (fig. 41) is carried by each rifleman. It contains a screwdriver, oil can, cleaning rod head, cleaning rod brush, cleaning rod attachment, rod collar, and cleaning rod stop (fig. 42). There are variations in the design of the oil can and screwdriver (fig. 43).

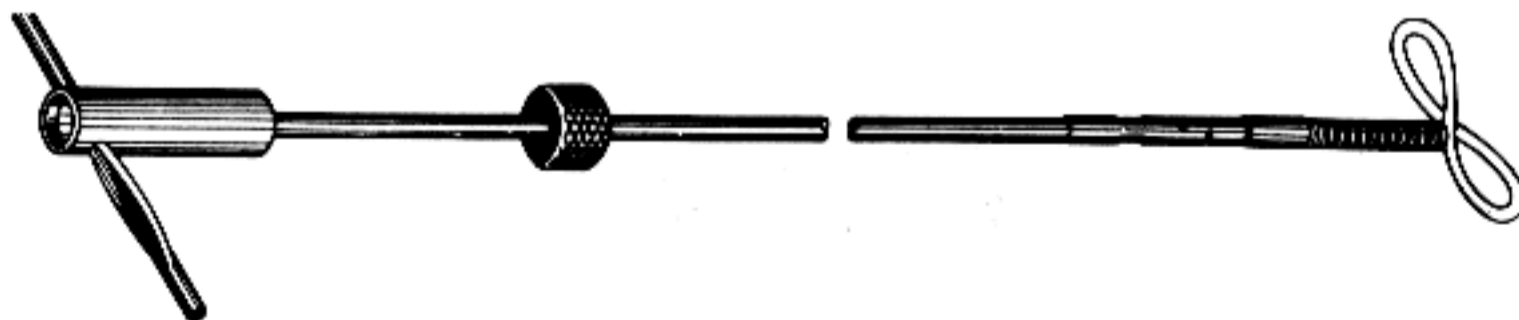

FIGURE 40. CLEANING ROD ASSEMBLY.



SOVIET RIFLES AND CARBINES  
IDENTIFICATION AND OPERATION

ORDI 7-101

May 1954

30. RIFLE M1891/30

a. Operating instructions for the rifle M1891/30 are the same as those for the rifle M1891.

b. The bayonet is attached by means of a spring-loaded catch.

31. SNIPER RIFLE M1891/30

a. Operating instructions for this rifle are the same as those for the rifle M1891. The bayonet for the rifle M1891/30 is attached to the sniper rifle by means of a spring-loaded catch.

b. Instructions for operating the rifle telescopes are given in paragraph 24.

32. CARBINE M1938

Operating instructions for this carbine are the same as those for the rifle M1891; however, bayonets are not provided for this carbine.

33. CARBINE M1944

Operating instructions for this carbine are the same as those for the rifle M1891; however, this carbine has a nondetachable bayonet which may be folded or extended by forcing the spring-loaded bayonet tube away from the pivot pin and then swinging the bayonet to either marching or combat position.

SECTION VII. MAINTENANCE

34. ACCESSORIES

Each Mosin-Nagant bolt action rifle and carbine is provided with a one-piece cleaning rod (fig. 40) which is fitted in the stock. The rod is threaded on the end to take the tapped retaining nut embedded in the stock just below the chamber (fig. 37). An accessory pouch (fig. 41) is carried by each rifleman. It contains a screwdriver, oil can, cleaning rod head, cleaning rod brush, cleaning rod attachment, rod collar, and cleaning rod stop (fig. 42). There are variations in the design of the oil can and screwdriver (fig. 43).

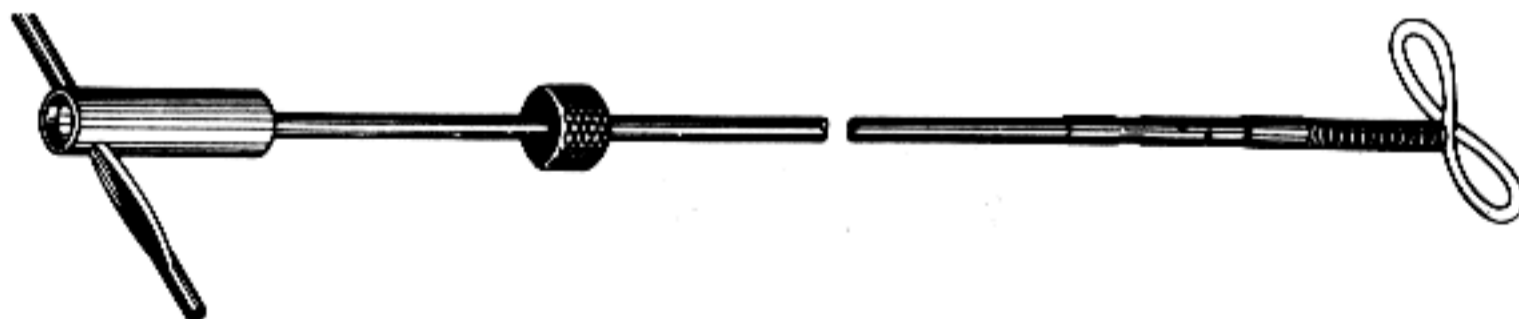

FIGURE 40. CLEANING ROD ASSEMBLY.





FIGURE 41. ACCESSORY POUCH.

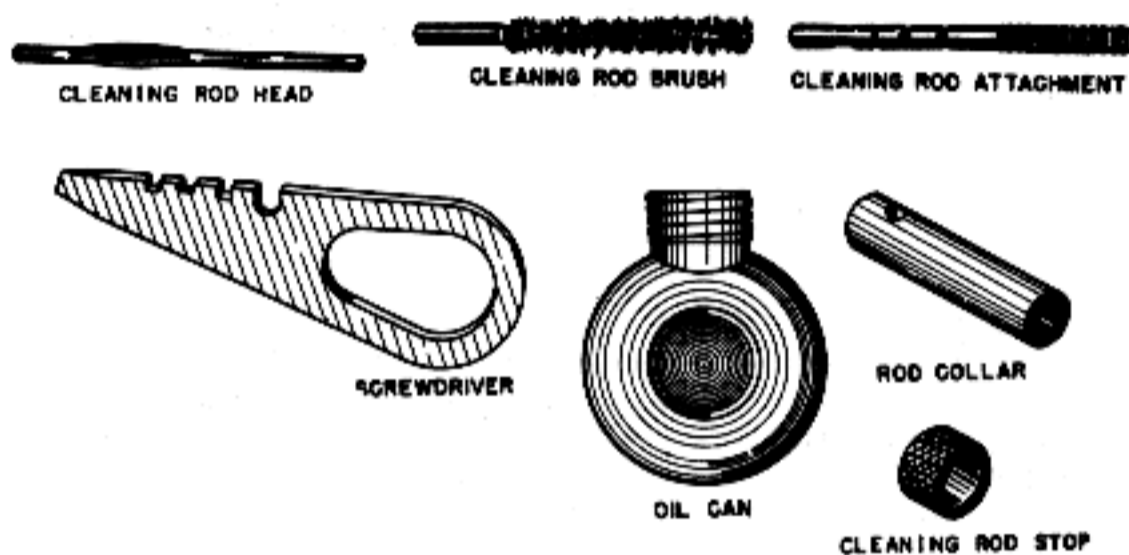

FIGURE 42. ACCESSORY POUCH CONTENTS.

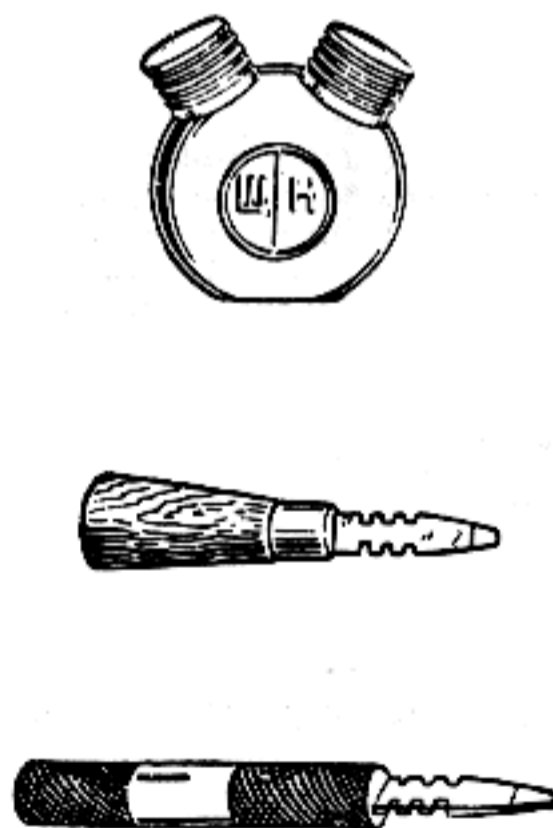

FIGURE 43. VARIATION IN DESIGN OF ACCESSORIES.

## 35. CARE AND CLEANING

The care and cleaning of the Soviet Mosin-Nagant bolt action weapons are the same as that required for the United States service rifle M1903.

## 36. RIFLE M1891

a. Disassembly.

- (1) To remove the bolt (fig. 44), squeeze the trigger and, at the same time, pull the bolt all the way to the rear (fig. 45).
- (2) To disassembly the bolt, draw the cocking piece back and turn it to the left to relieve spring tension (fig. 46). Remove the bolt head and guide. Place the firing pin on a solid surface, push the bolt body down, and unscrew the cocking piece (fig. 47); then remove the firing pin and spring. The components of the bolt assembly are illustrated in figure 48.
- (3) To remove the magazine follower, push the magazine floor plate catch rearward (the catch is on the bottom of the magazine, just forward of the trigger guard); at the same time, pull the floor plate down. The follower and floor plate (fig. 39) will swing down and forward on a pivot pin. Grasp the follower and floor plate with the forefinger and thumb, press them together, and pull down to remove them.
- (4) To remove the magazine and trigger guard, extract the rear trigger guard screw from the top of the stock just forward of the small of the stock, and the front trigger guard screw from the forward part of the magazine on the bottom of the stock (figs. 49 and 50). (A screwdriver provided in the accessory kit is used for this purpose.) Pull the magazine and trigger guard (fig. 51) out of the stock.
- (5) The stock bands are removed by turning the screw to the right to expand the bands, then slipping the bands forward and off the stock.
- (6) To remove the one-piece interrupter-ejector, remove the screw and push the interrupter-ejector forward until it is disengaged from the dovetail.

b. Assembly. Assembly is accomplished in the reverse order of disassembly, described in a above. It is necessary to make certain that the rear of the firing pin is flush with the cocking piece, and that the marks on the rear of the firing pin are alined with those on the cocking piece, in order to assure correct protrusion of the firing pin.





FIGURE 45. REMOVING THE BOLT.

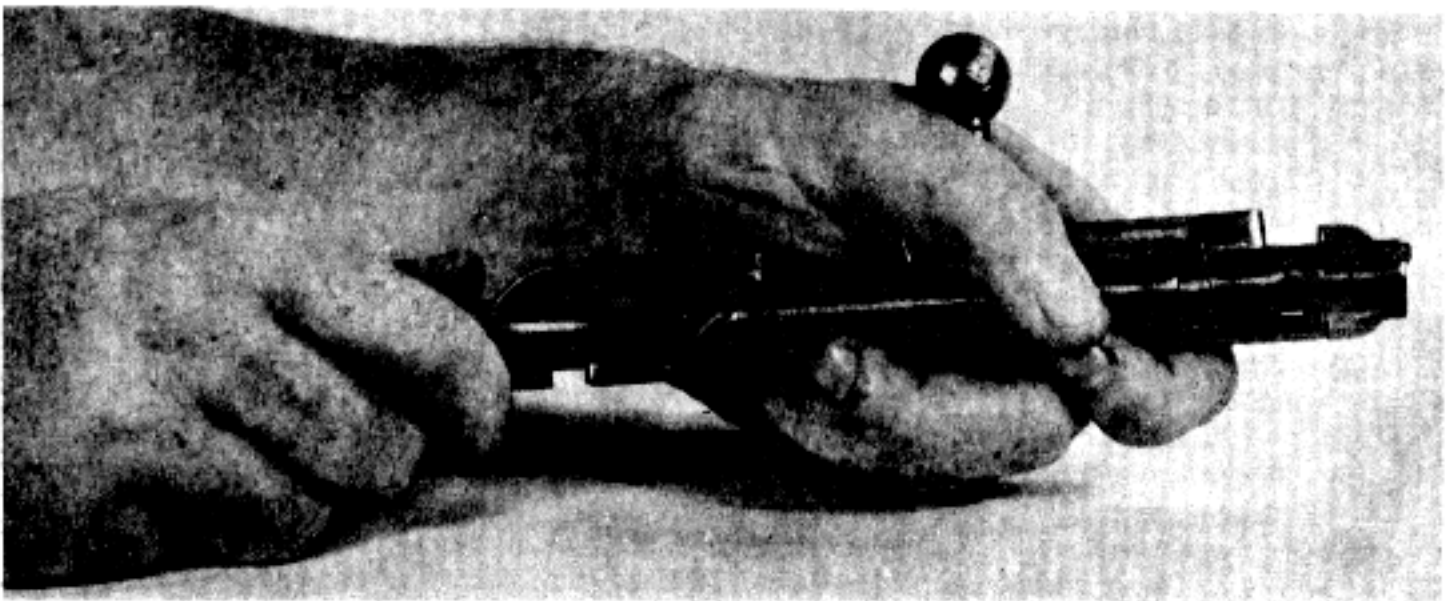

FIGURE 46. DRAWING COCKING PIECE BACK.

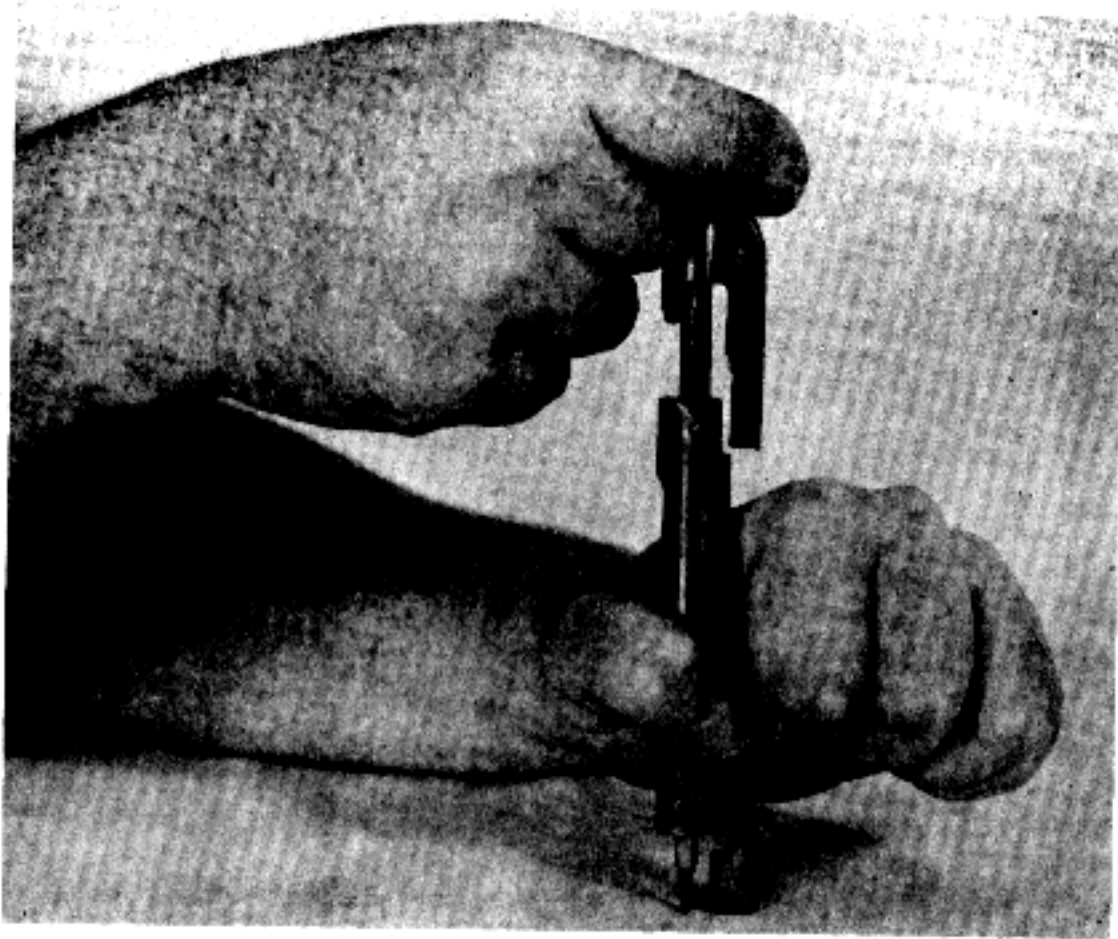

FIGURE 47. REMOVING COCKING PIECE.

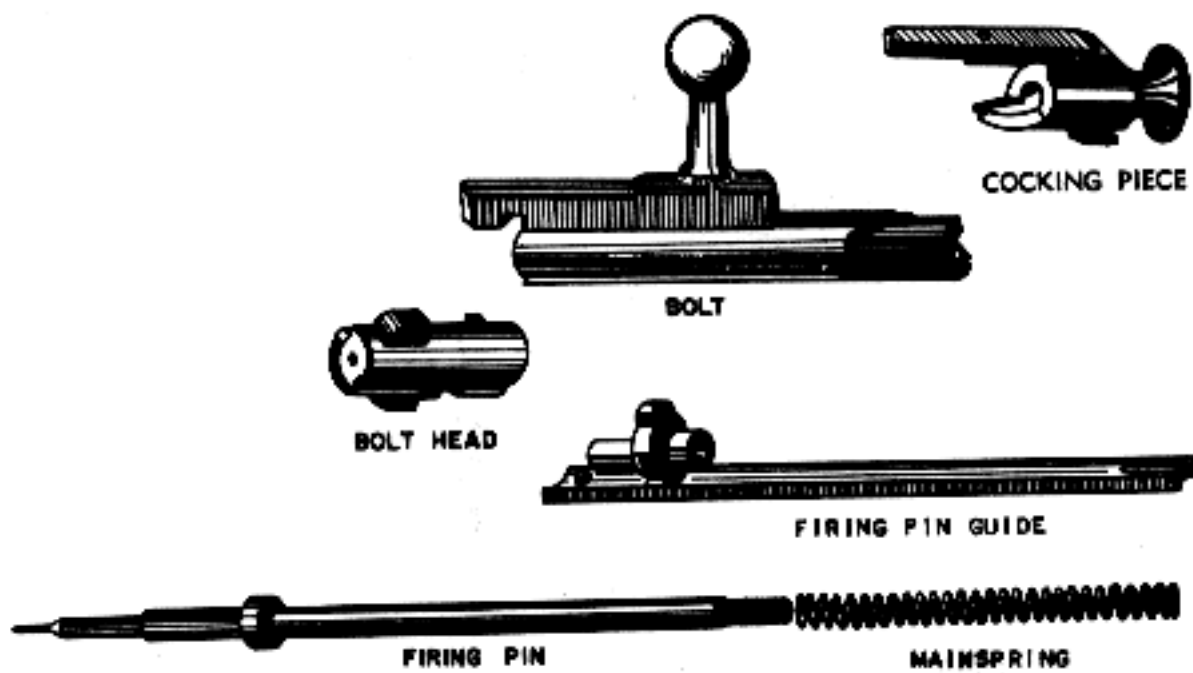

FIGURE 48. BOLT ASSEMBLY COMPONENTS.

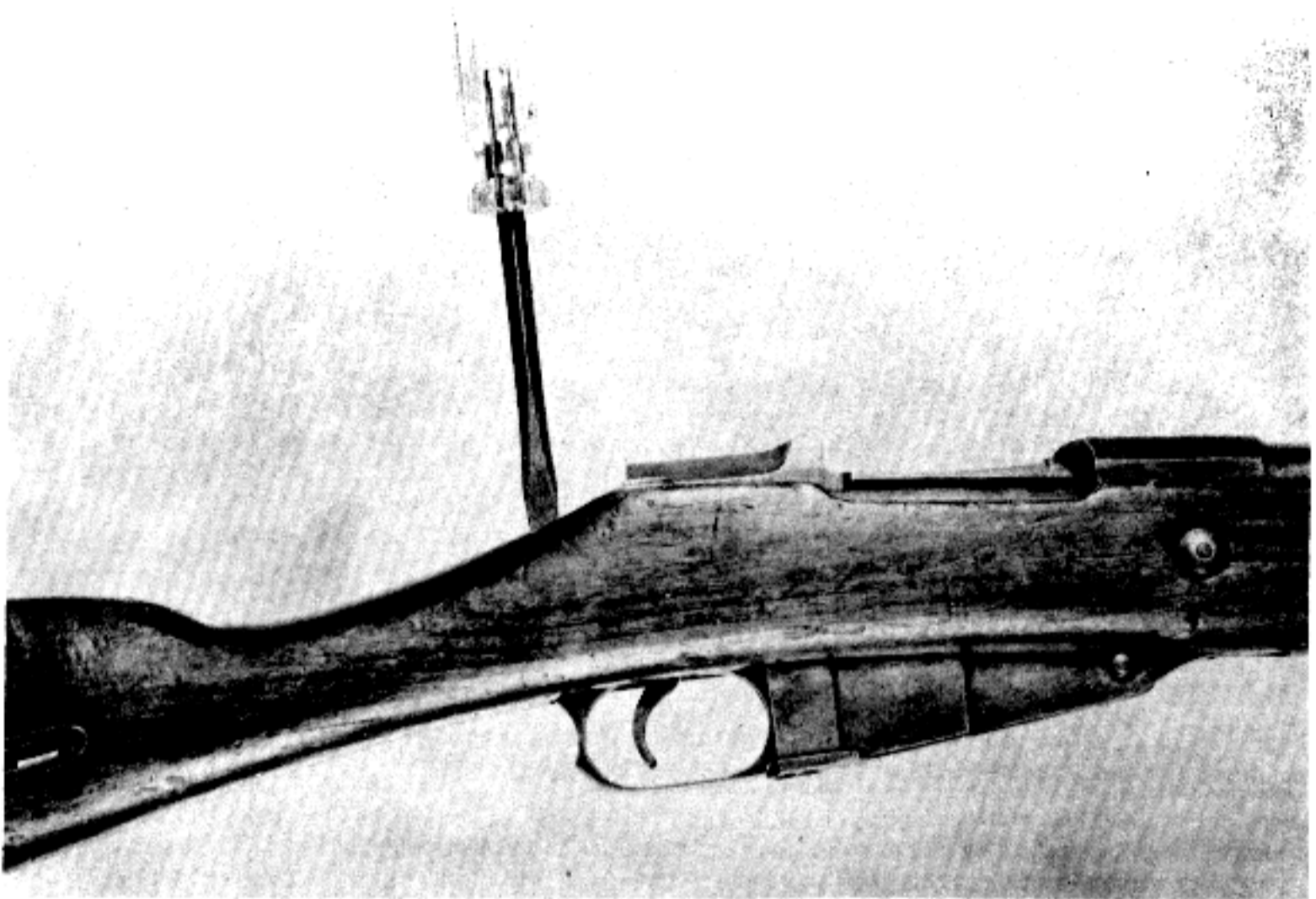

FIGURE 49. REMOVING REAR TRIGGER GUARD SCREW.

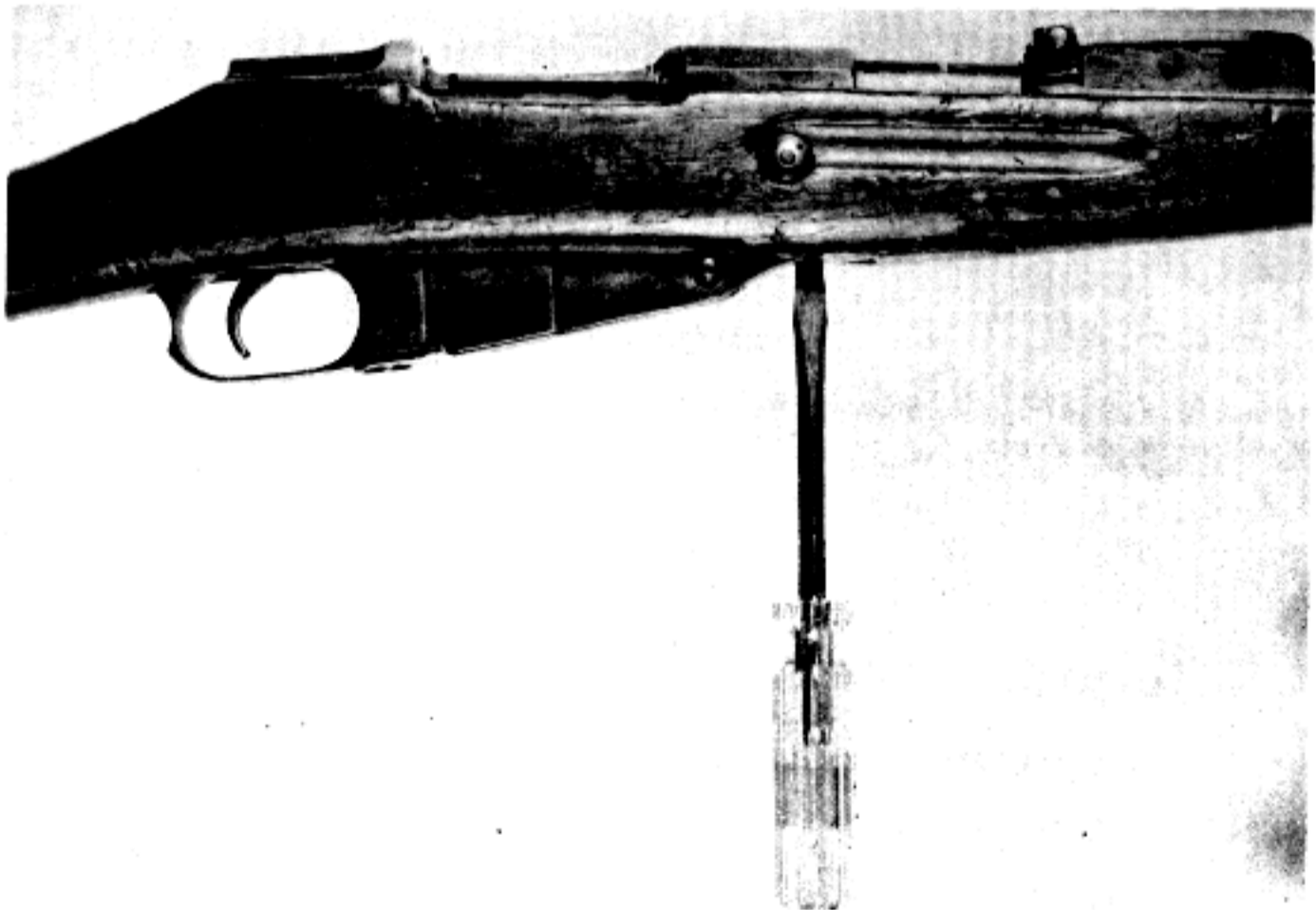

FIGURE 50. REMOVING THE FRONT TRIGGER GUARD SCREW.

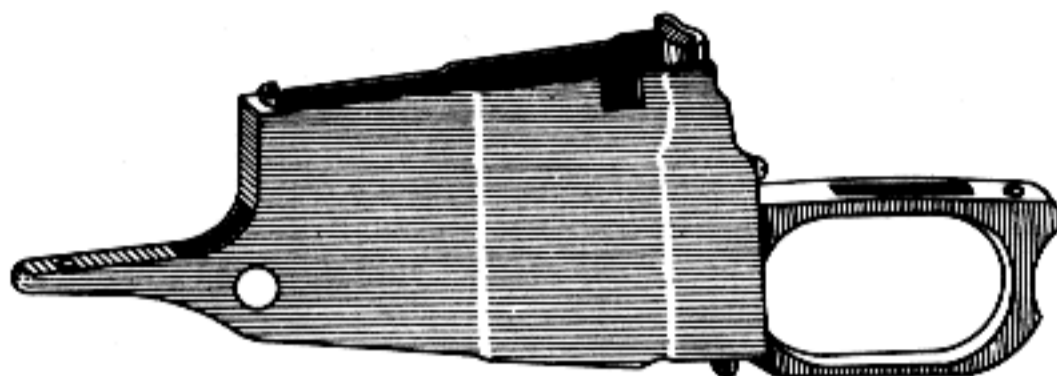

FIGURE 51. MAGAZINE AND TRIGGER GUARD.

**37. DRAGOON RIFLE M1891**

The disassembly of the Dragoon rifle M1891 is the same as that of the rifle M1891, except with regard to the stock bands. To remove the stock bands of the M1891 Dragoon, depress the band retaining springs and slide the bands forward.

**38. CARBINE M1910**

Disassembly of the carbine M1910 is the same as that of the rifle M1891, except that band retaining springs must be depressed to remove the stock bands.

**39. RIFLE M1891/30**

Disassembly of the rifle M1891/30 is the same as that of the M1891, except that band retaining springs must be depressed to remove the split-ring stock bands.

**40. SNIPER RIFLE M1891/30**

The sniper rifle M1891/30 is disassembled in the same manner as the rifle M1891/30; however, the telescope must be sent to a fire control maintenance unit for disassembly, repairs, or adjustment.

**41. CARBINE M1938**

The carbine M1938 is disassembled in the same manner as the rifle M1891/30.

**42. CARBINE M1944**

The carbine M1944 is disassembled in the same manner as the rifle M1891/30; however, the bayonet is not detachable.

**SECTION VIII. MALFUNCTIONS AFFECTING OPERATIONS****43. GENERAL**

Stoppages are usually caused by improper assembly or improper loading of the magazine, but they also may be caused by dirt, breakage of parts, or defective ammunition. When a stoppage occurs, check the weapon quickly, cock the hammer, and fire again. If the weapon still fails to fire, take corrective action.



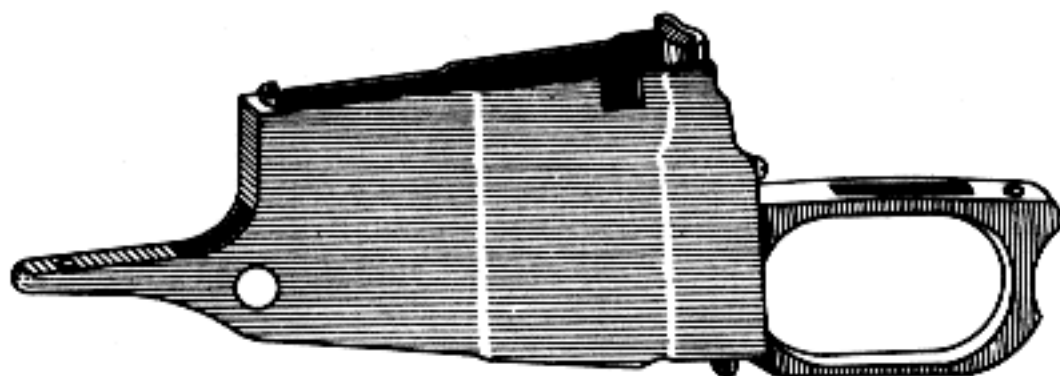

FIGURE 51. MAGAZINE AND TRIGGER GUARD.

**37. DRAGOON RIFLE M1891**

The disassembly of the Dragoon rifle M1891 is the same as that of the rifle M1891, except with regard to the stock bands. To remove the stock bands of the M1891 Dragoon, depress the band retaining springs and slide the bands forward.

**38. CARBINE M1910**

Disassembly of the carbine M1910 is the same as that of the rifle M1891, except that band retaining springs must be depressed to remove the stock bands.

**39. RIFLE M1891/30**

Disassembly of the rifle M1891/30 is the same as that of the M1891, except that band retaining springs must be depressed to remove the split-ring stock bands.

**40. SNIPER RIFLE M1891/30**

The sniper rifle M1891/30 is disassembled in the same manner as the rifle M1891/30; however, the telescope must be sent to a fire control maintenance unit for disassembly, repairs, or adjustment.

**41. CARBINE M1938**

The carbine M1938 is disassembled in the same manner as the rifle M1891/30.

**42. CARBINE M1944**

The carbine M1944 is disassembled in the same manner as the rifle M1891/30; however, the bayonet is not detachable.

**SECTION VIII. MALFUNCTIONS AFFECTING OPERATIONS**

**43. GENERAL**

Stoppages are usually caused by improper assembly or improper loading of the magazine, but they also may be caused by dirt, breakage of parts, or defective ammunition. When a stoppage occurs, check the weapon quickly, cock the hammer, and fire again. If the weapon still fails to fire, take corrective action.



44. CAUSES AND CORRECTION OF COMMON MALFUNCTIONS

The malfunctions occurring most frequently, their probable cause, and the proper remedial action necessary to overcome the stoppage are listed below.

| Malfunction   | Probable cause   | Remedial action   |
|---|--|---|
| 1. Magazine floor plate falls open.                               | a. Defective floor plate catch.<br>b. Screw is weakened, tooth worn or chamfered.  | a. Load and fire single rounds until fire is completed.<br>b. Tighten screw.  |
| 2. Cartridge jams in process of being chambered.                  | a. Defective interrupter-ejector.<br>b. Cartridge not positioned below interrupter-ejector blade.                                      | a. Clean and oil interrupter-ejector blade.<br>b. Correct position of cartridge by hand and chamber round.                  |
| 3. Cartridge is chambered with difficulty.                        | a. Dented cartridge case.<br>b. Dirty chamber.<br>c. Excessive primer protrusion.  | a. Remove defective cartridge.<br>b. Clean chamber.<br>c. Remove defective cartridge.                                       |
| 4. Misfire.   | a. Defective primer.<br>b. Firing pin protrusion insufficient.<br>c. Firing pin spring weak or broken.<br>d. Dirt in firing mechanism. | a. Reload and continue firing.<br>b. Adjust firing pin protrusion.<br>c. Turn in weapon to Ordnance.<br>d. Clean mechanism. |
| 5. Fails to extract.  | Defective extractor.   | Turn in weapon to Ordnance.   |
| 6. Fails to eject.  | a. Interrupter-ejector spring-portion is bent.<br>b. Dirt in interrupter-ejector slot.   | a. Turn in weapon to Ordnance.<br>b. Clean and oil.   |
| 7. Bolt is pulled out of receiver during process of opening bolt. | a. Loose trigger-spring screw.<br>b. Worn bolt stop.   | a. Tighten trigger-spring screw.<br>b. Turn in weapon to Ordnance.  |